

Emanet Servisi İşlem Süreci

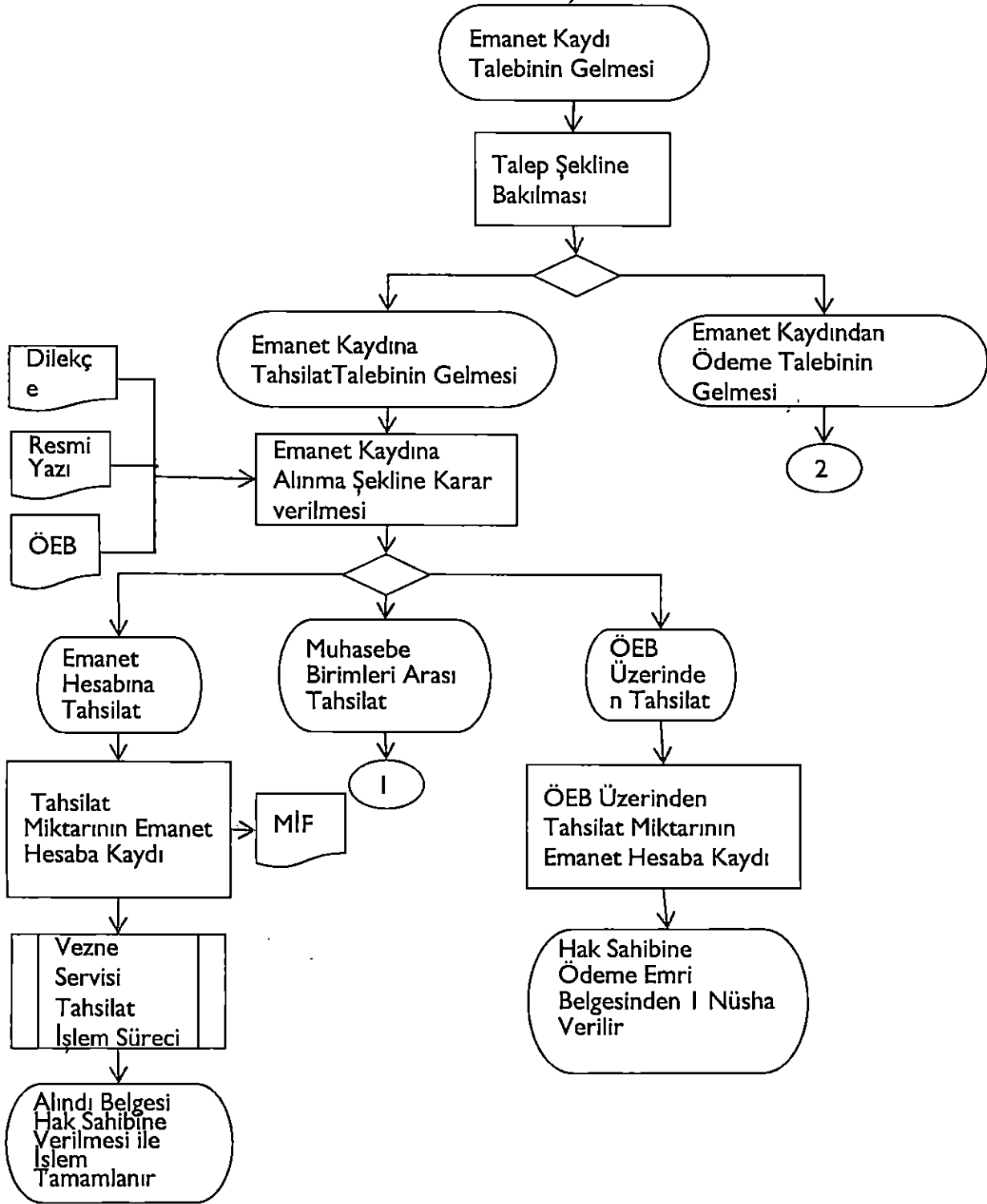

Hazırlayan:	Onaylayan:
Türkan TARCAN Muhasebe Şefi	Kadri AY Muhasebe Müdürü

Emanet Servisi İşlem Süreci

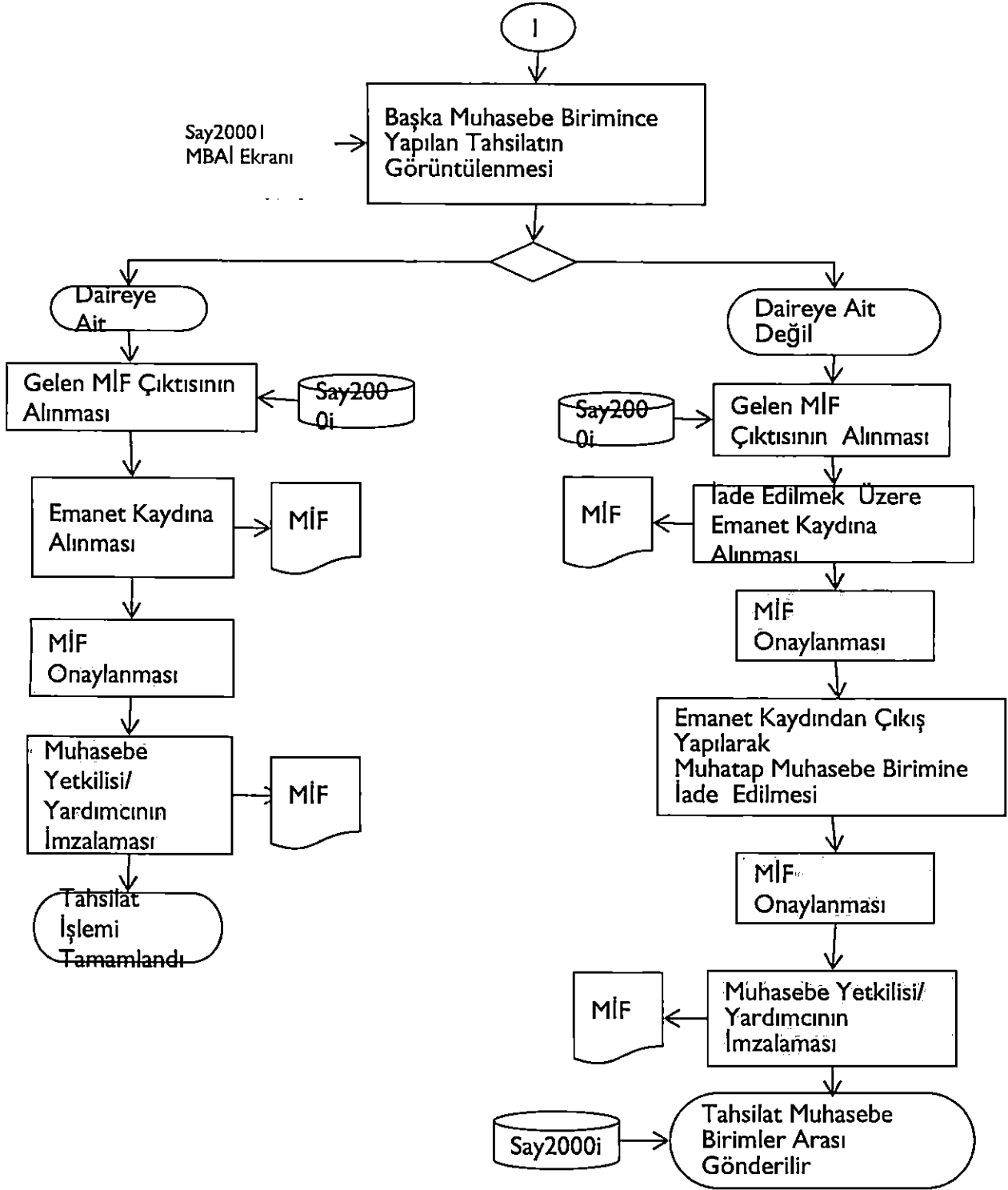

Hazırlayan:	Onaylayan:
Türkan TARCAN Muhasebe Şefi	Kadri AY Muhasebe Müdürü

Emanet Servisi İşlem Süreci

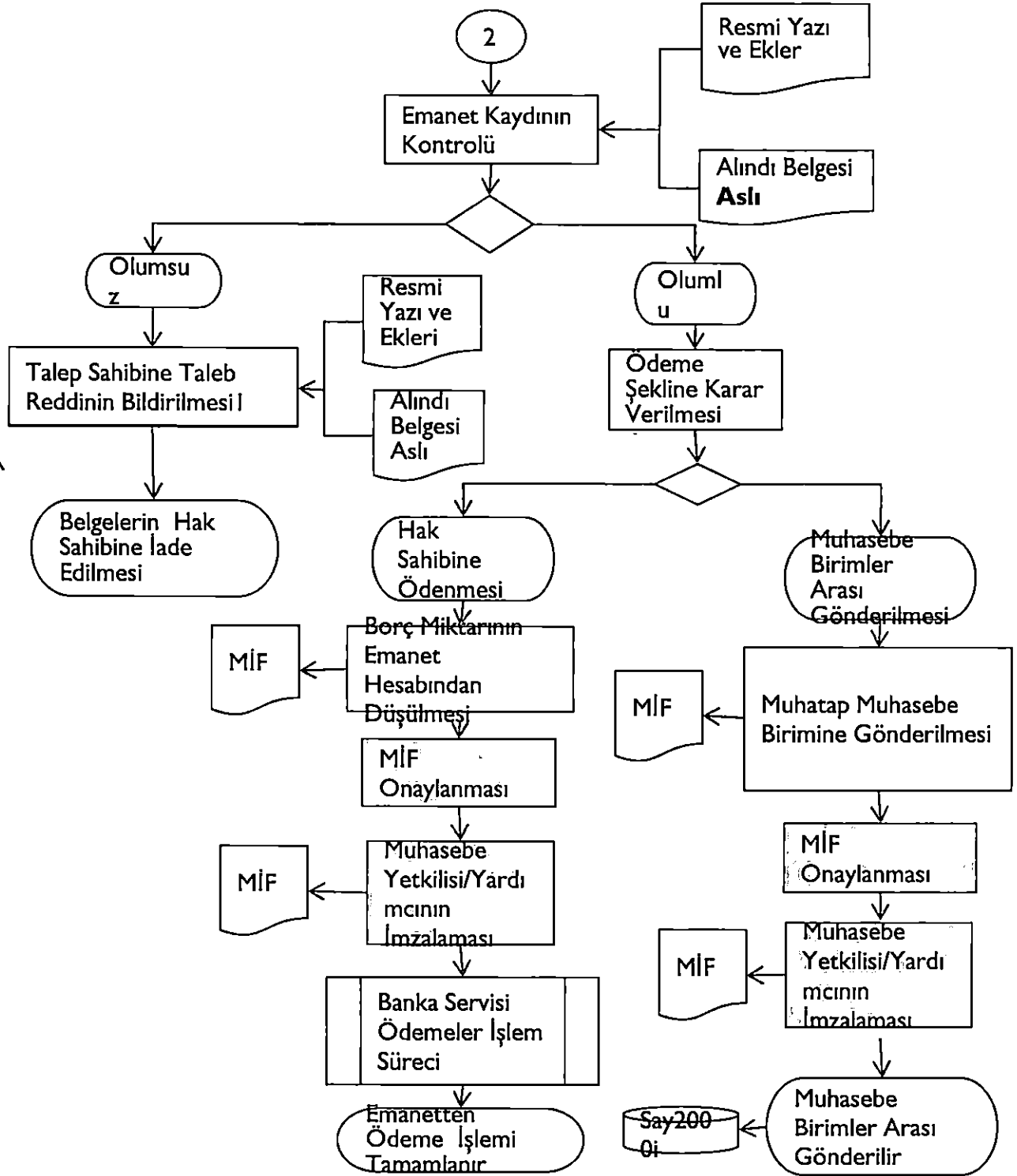

Hazırlayan:	Onaylayan:
Türkan TARCAN Muhasebe Şefi	Kadri AY Muhasebe Müdürü

Kati Ödeme Belgesine Bağlı İşlem Süreci

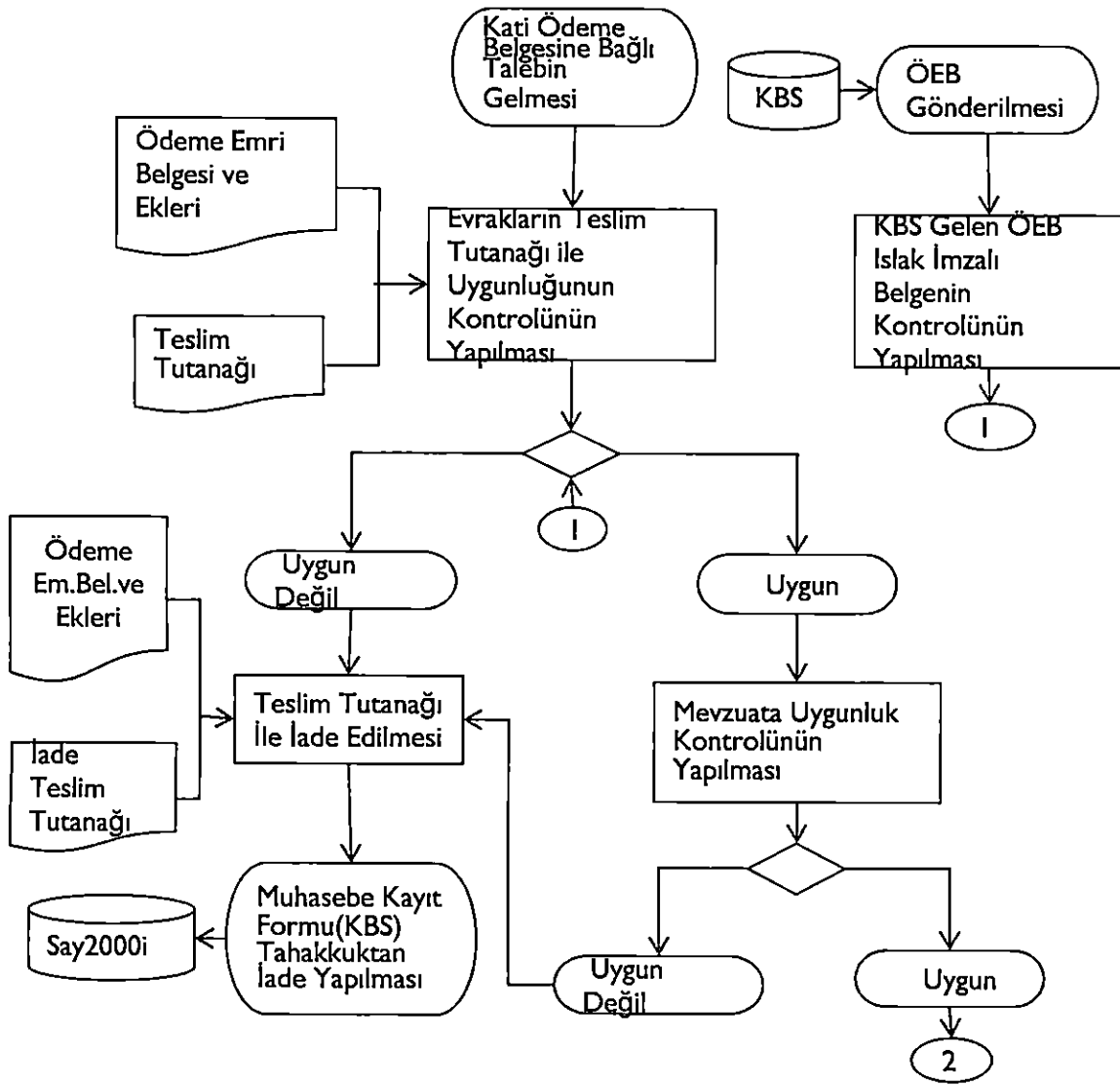

Hazırlayan:	Onaylayan:
Türkan TARCAN Muhasebe Şefi	Kadri AY Muhasebe Yetkilisi

Kati Ödeme Belgesine Bağlı İşlem Süreci

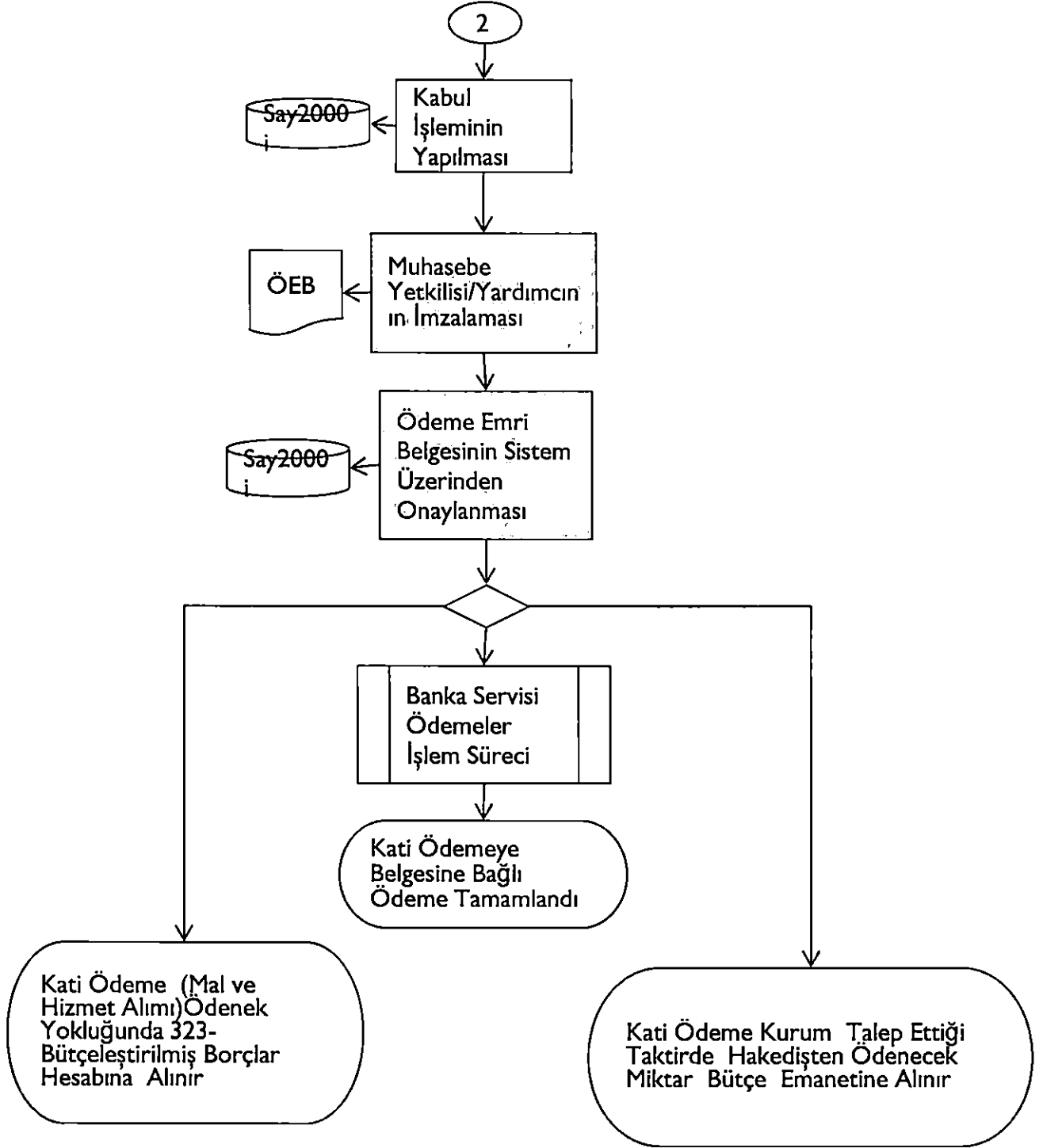

Hazırlayan:	Onaylayan:
Türkan TARCAN Muhasebe Şefi	Kadri AY Muhasebe Yetkilisi

Özlük Servisi Sıhhi İzin İşlem Süreci

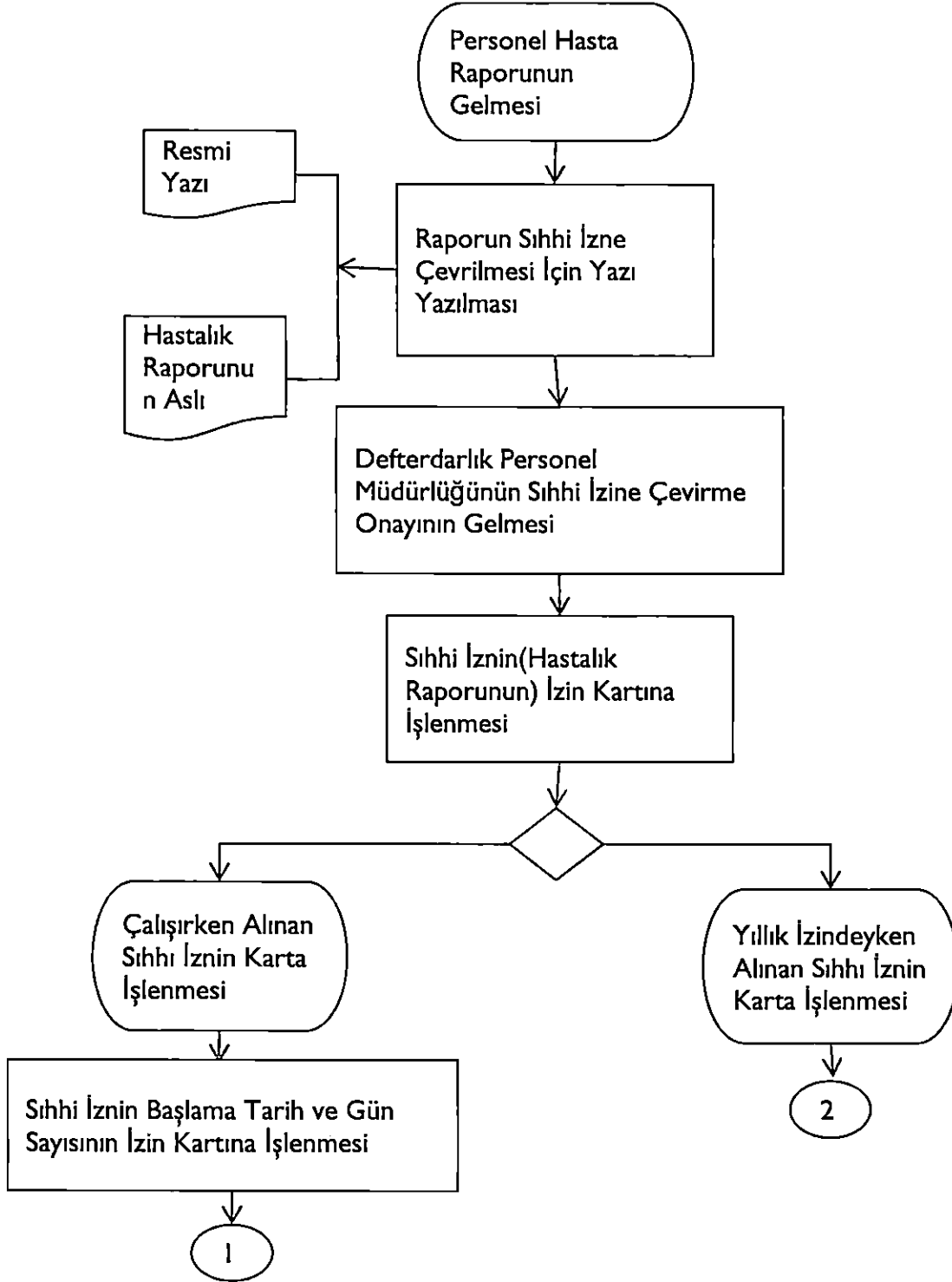

Hazırlayan:	Onaylayan:
Türkan TARCAN Muhasebe Şefi	Kadri AY Muhasebe Müdürü

Özlük Servisi Sıhhi İzin İşlem Süreci

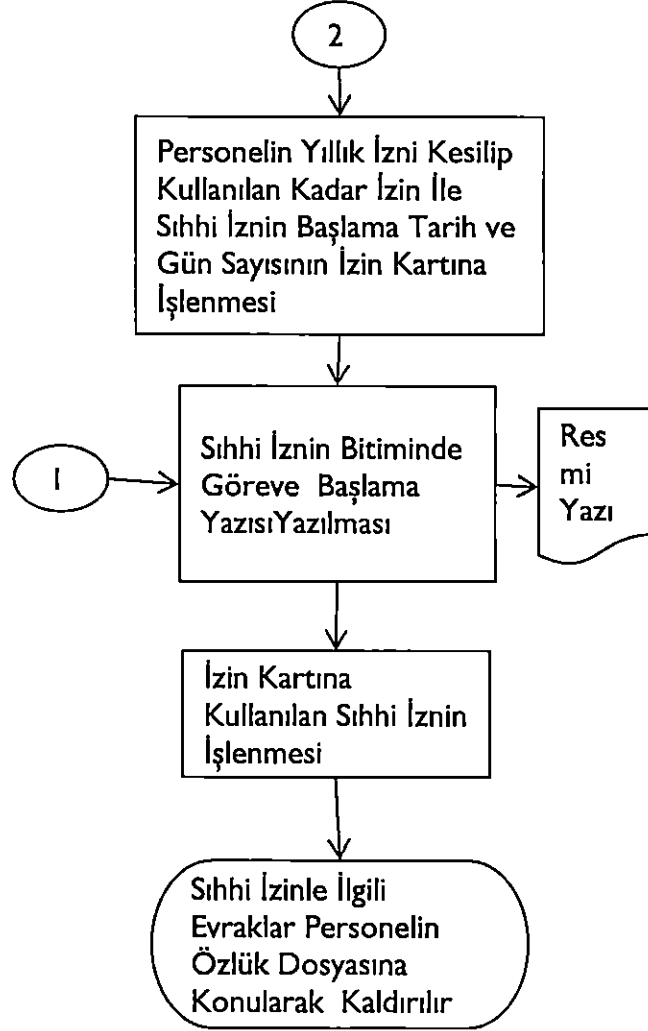

Hazırlayan:	Onaylayan:
Türkan TARCAN Muhasebe Şefi	Kadri AY Muhasebe Müdürü

Teminat Mektubu İşlem Süreci

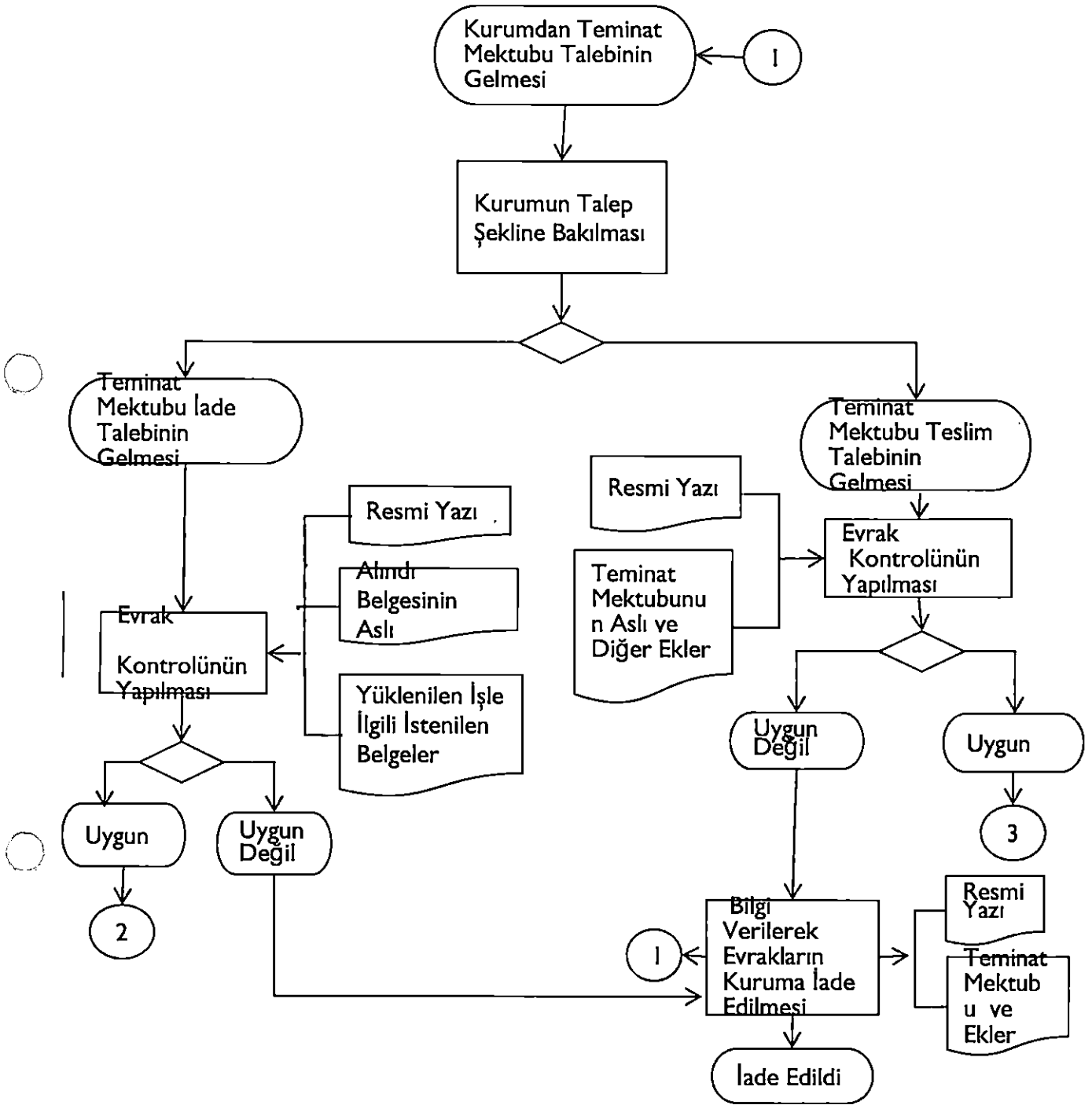

Hazırlayan:	Onaylayan:
Türkan TARCAN Muhasebe Şefi	Kadri AY Muhasebe Müdürü

Teminat Mektupları İşlem Süreci

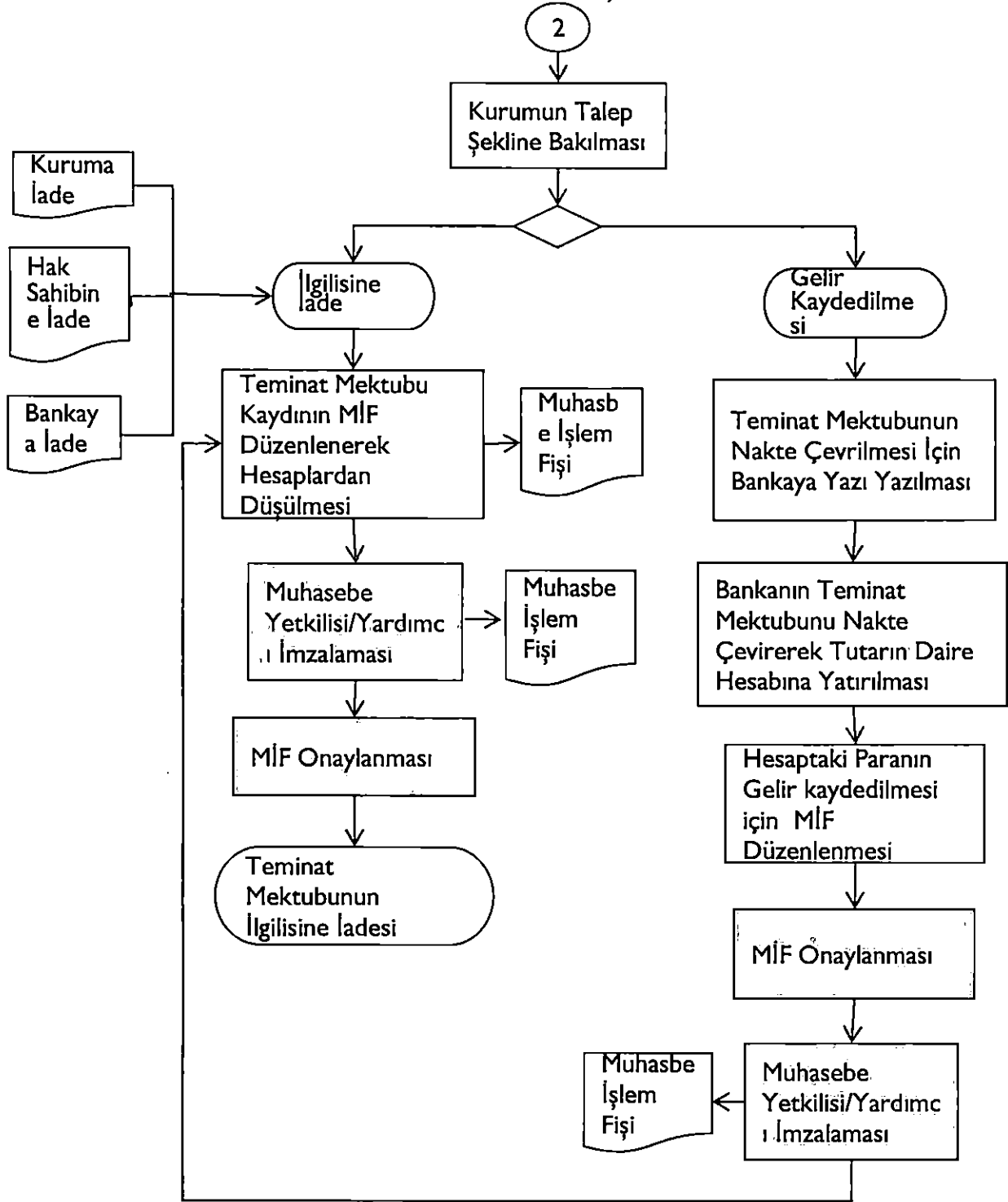

Hazırlayan:

Türkan TARCAN
Muhasebe Şefi

Onaylayan:

Kadri AY
Muhasebe Müdürü

Teminat Mektupları İşlem Süreci

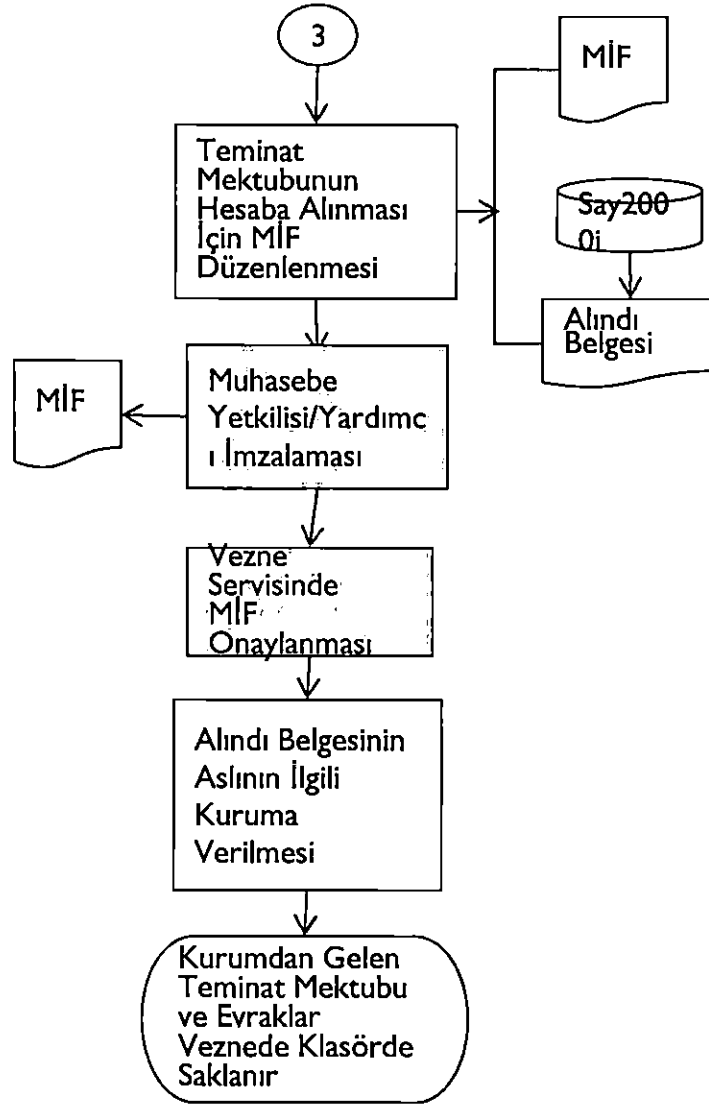

Hazırlayan:	Onaylayan:
Türkan TARCAN Muhasebe Şefi	Kadri AY Muhasebe Müdürü

Vezne Servisi Tahsilat İşlem Süreci

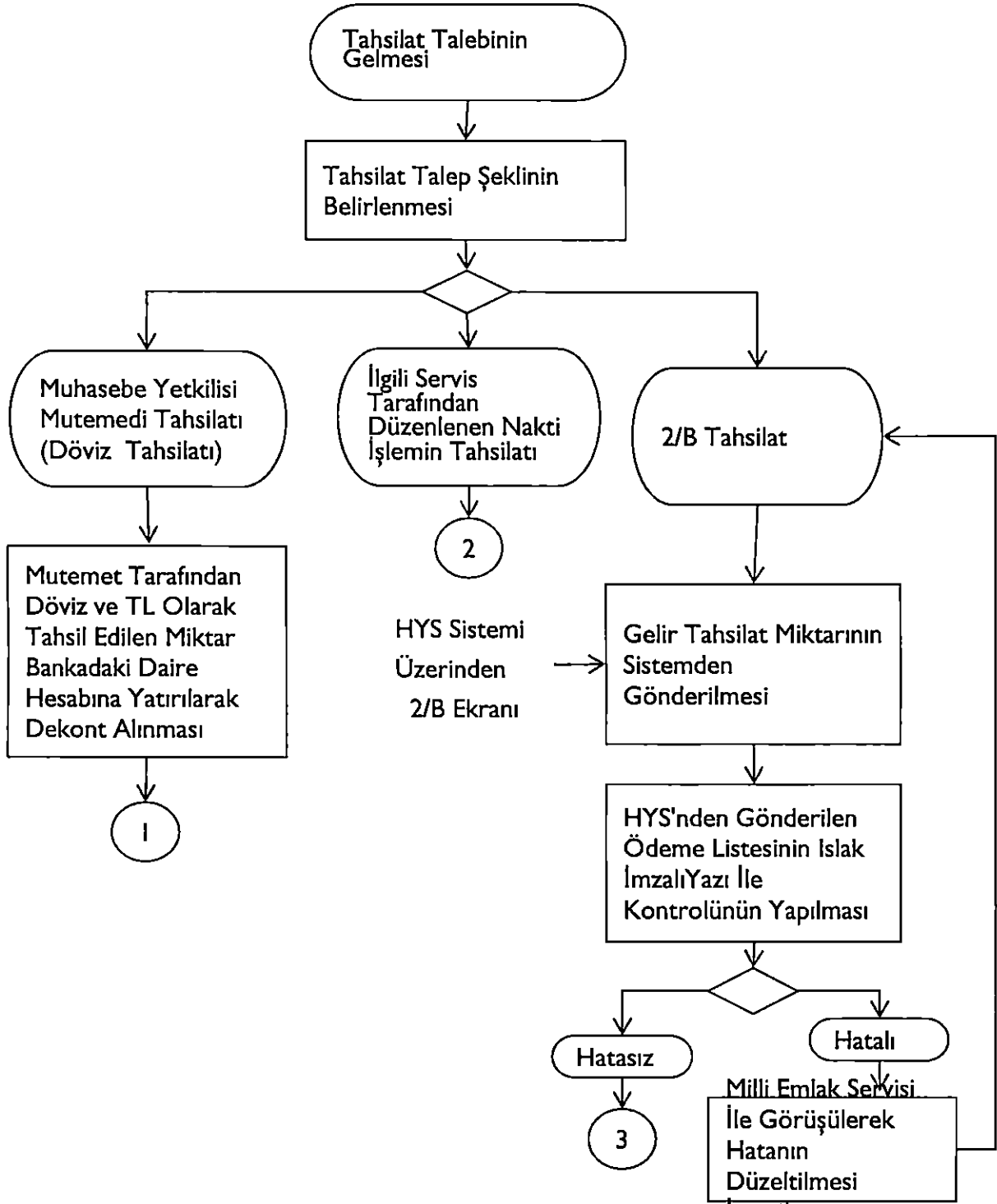

Hazırlayan:	Onaylayan:
Türkan TARCAN Muhasebe Şefi	Kadri AY Muhasebe Müdürü

Vezne Servisi Tahsilat İşlem Süreci

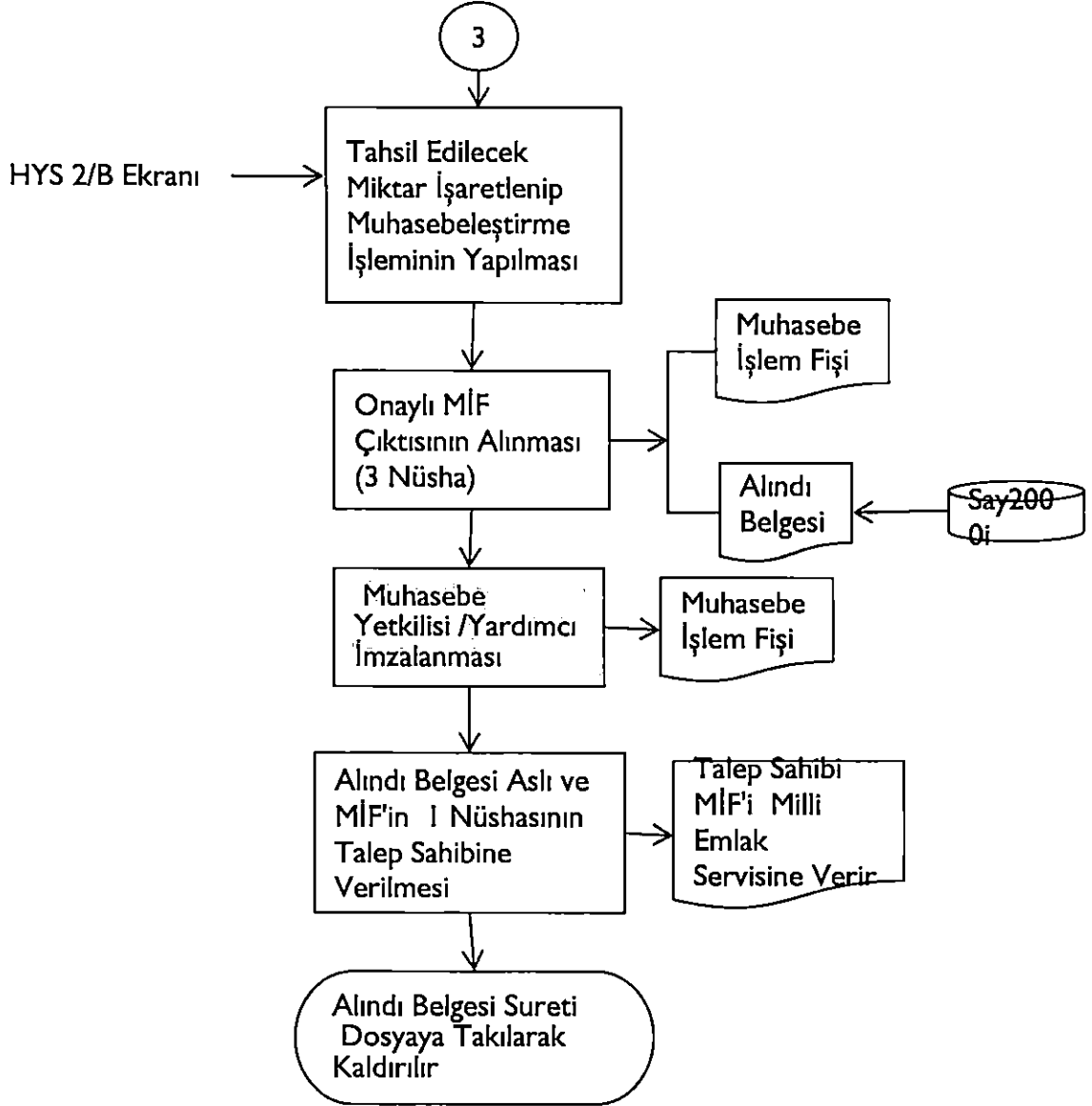

Hazırlayan:	Onaylayan:
Türkan TARCAN Muhasebe Şefi	Kadri AY Muhasebe Müdürü

Vezne Servisi Tahsilat İşlem Süreci

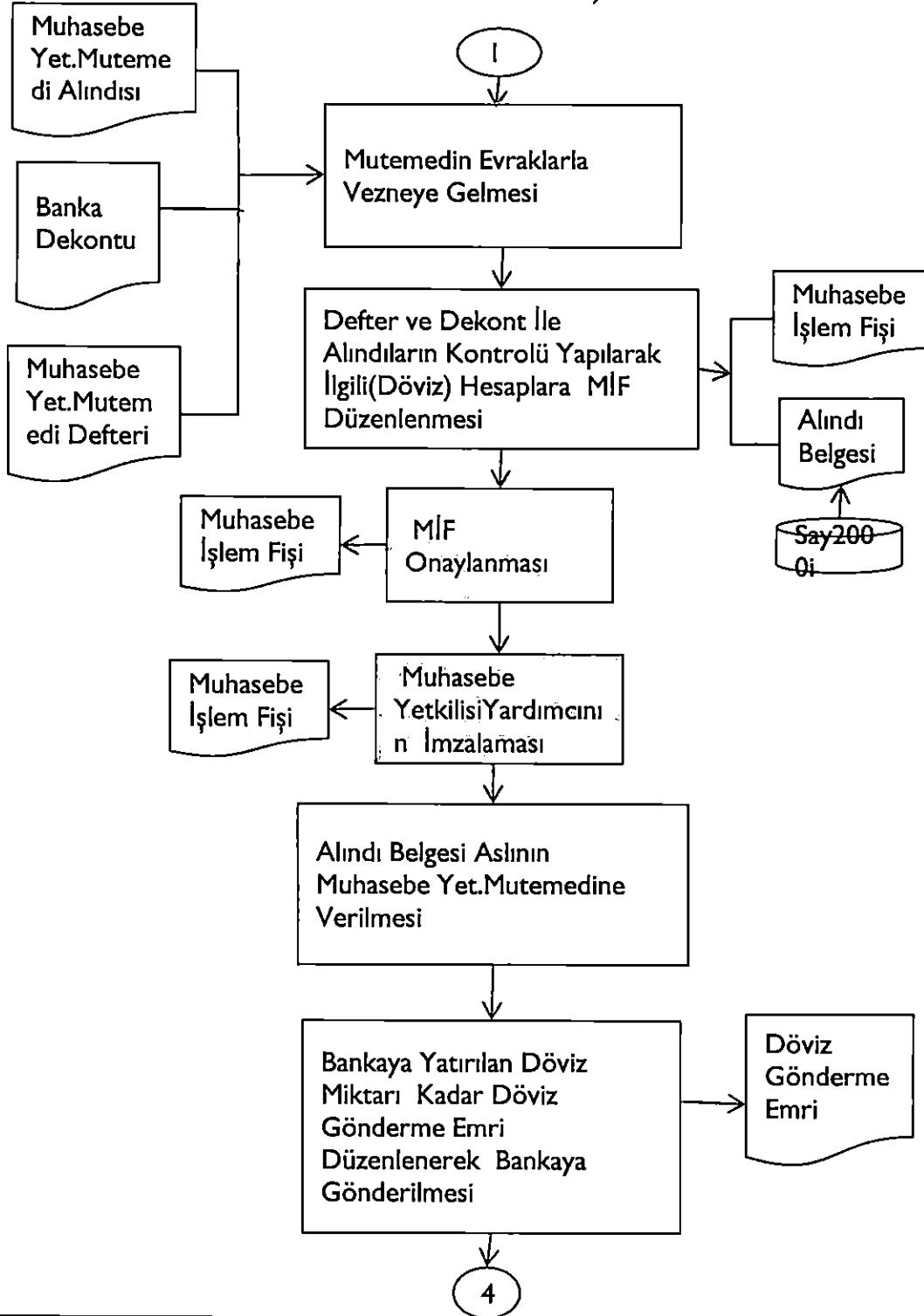

Hazırlayan:	Onaylayan:
Türkan TARCAN Muhasebe Şefi	Kadri AY Muhasebe Müdürü

Vezne Servisi Tahsilat İşlem Süreci

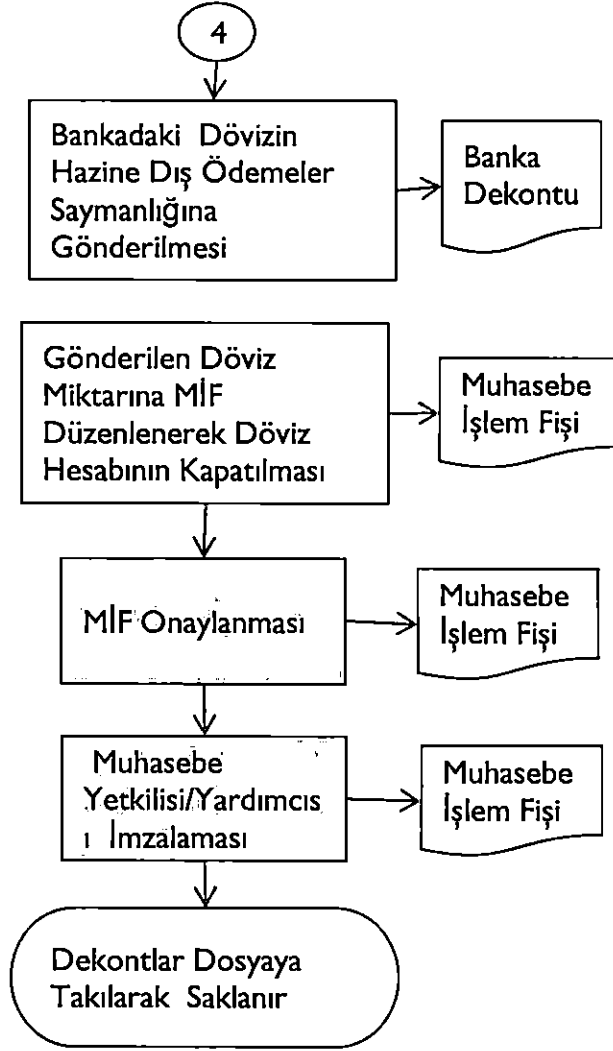

Hazırlayan:	Onaylayan:
Türkan TARCAN Muhasebe Şefi	Kadri AY Muhasebe Müdürü

Vezne Servisi Tahsilat İşlem Süreci

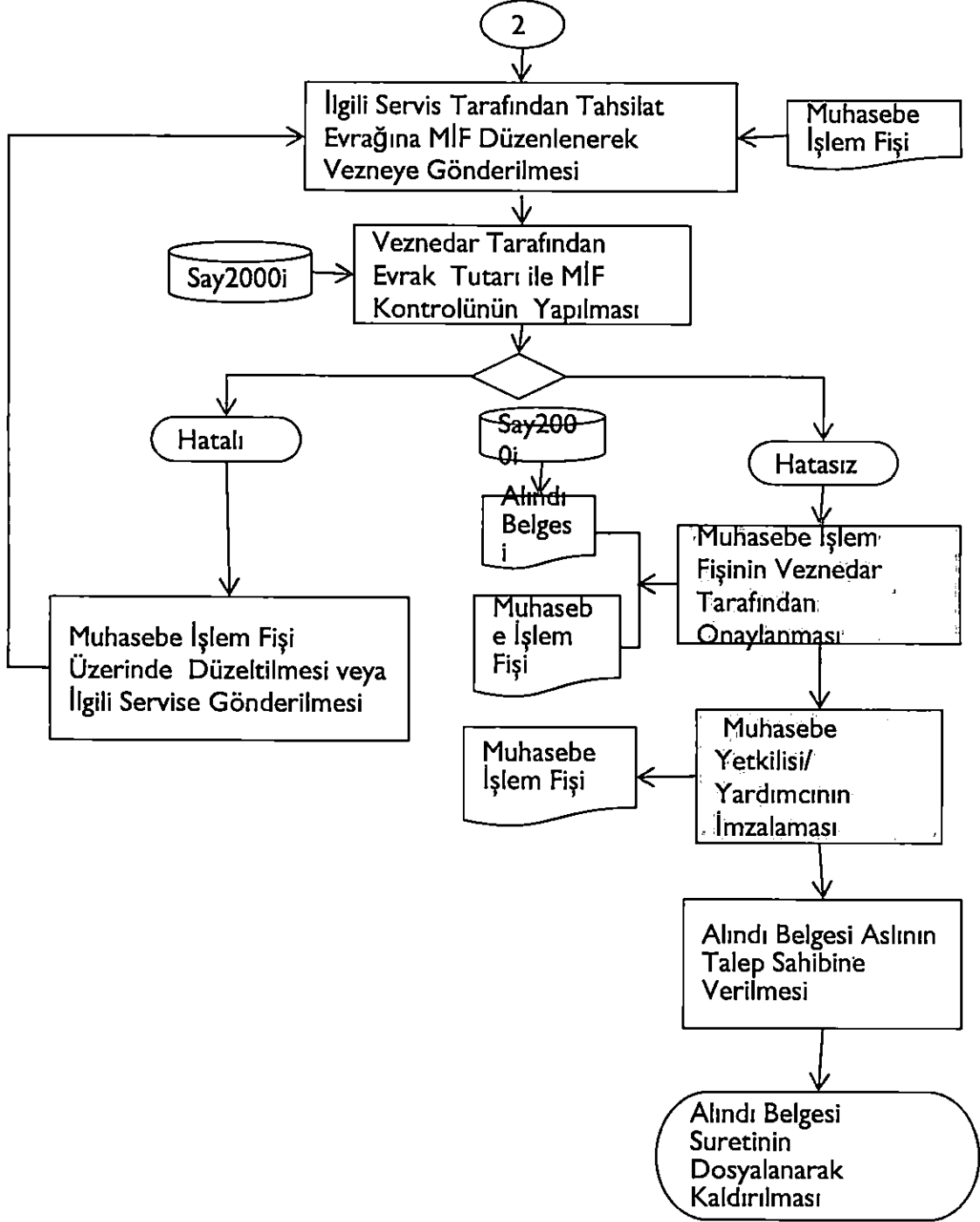

Hazırlayan:

Türkan TARCAN
Muhasebe Şefi

Onaylayan:

Kadri AY
Muhasebe Müdürü

Ay Sonu İşlem Süreci

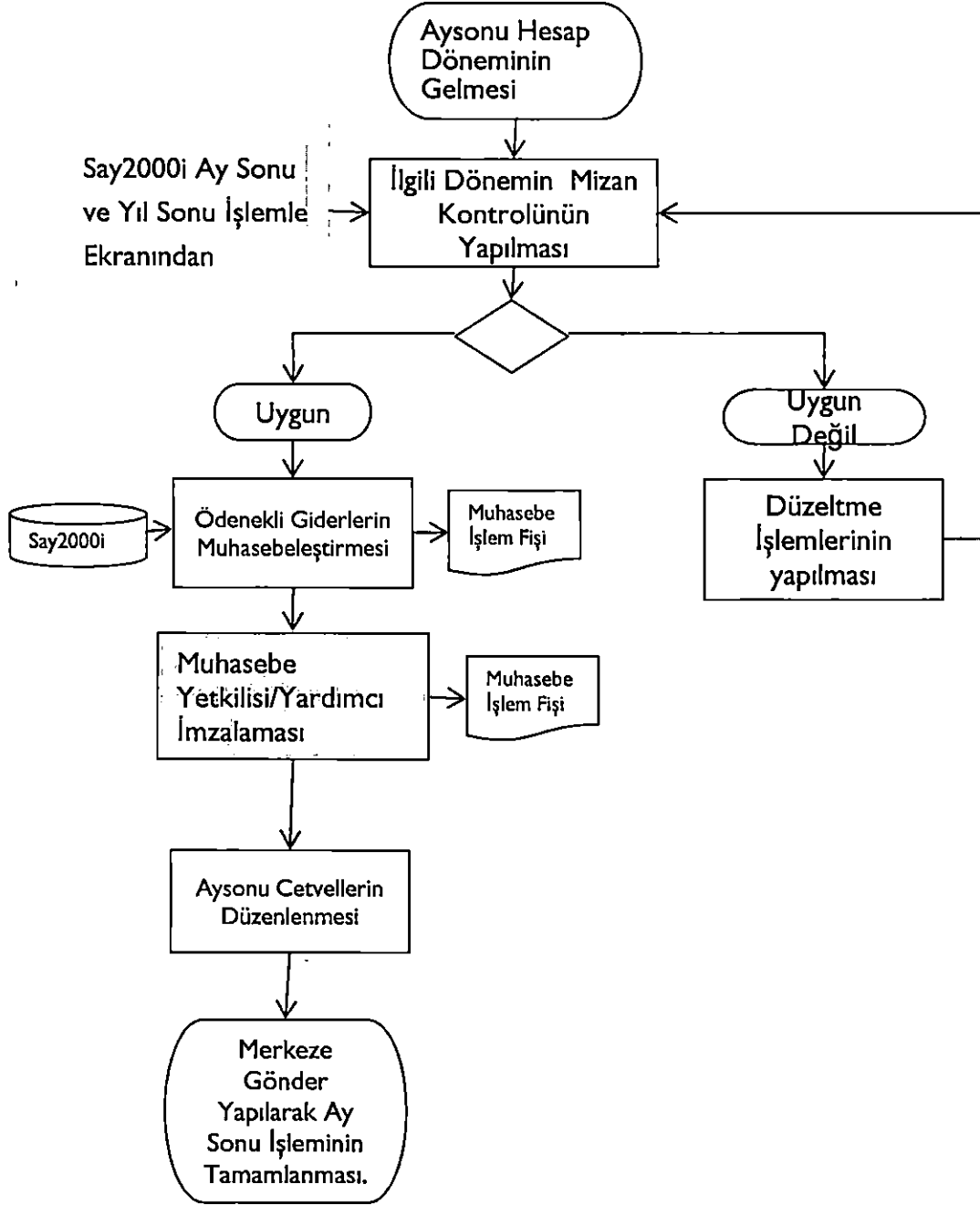

Hazırlayan:	Onaylayan:
Türkan TARCAN Muhasebe Şefi	Kadri AY Muhasebe Yetkilisi

Banka Servisi Gümrük Tahsilat İşlem Süreci

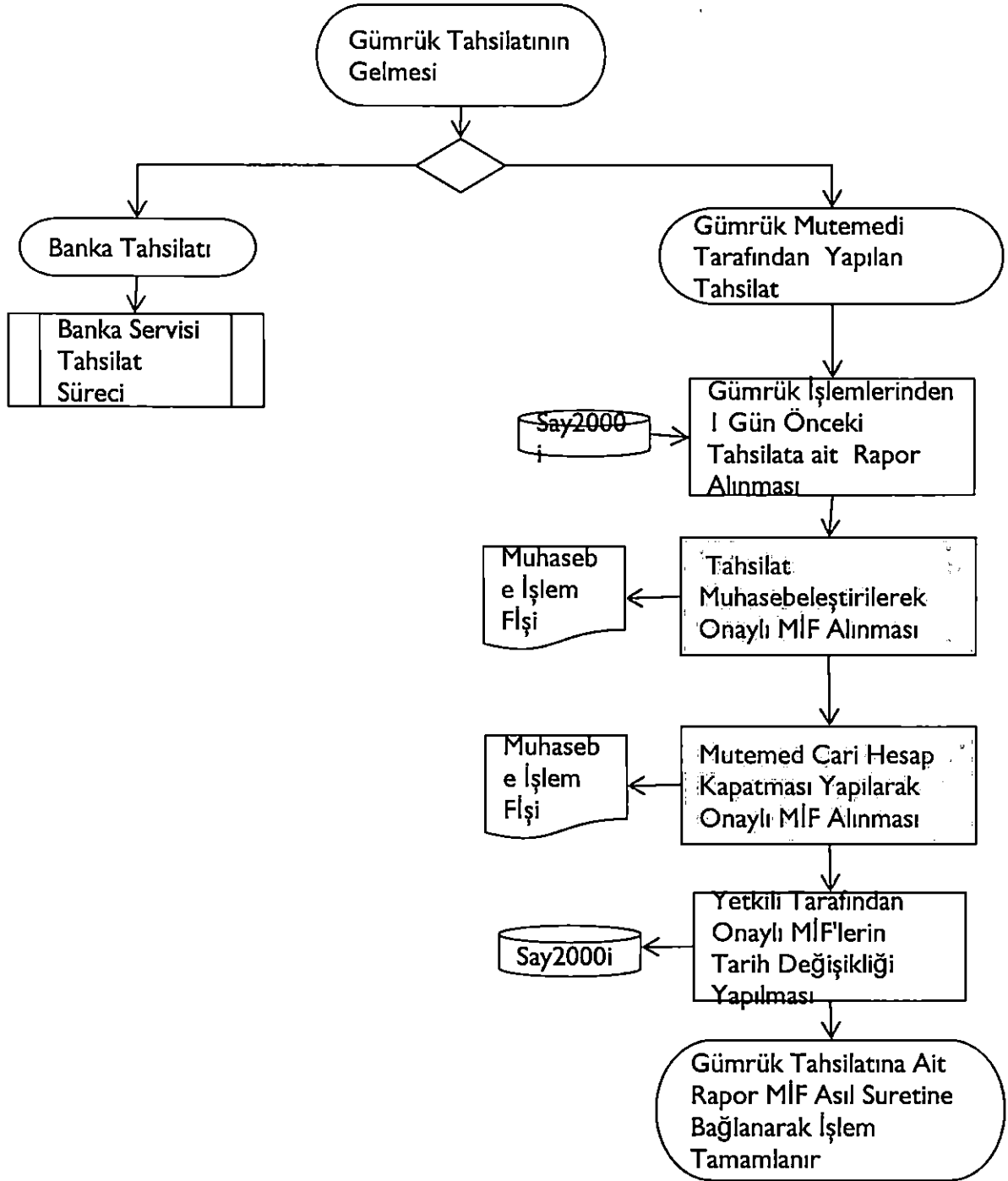

Hazırlayan:	Onaylayan:
Türkan TARCAN Muhasebe Şefi	Kadri AY Muhasebe Müdürü

Banka Servisi Ödeme İşlem Süreci

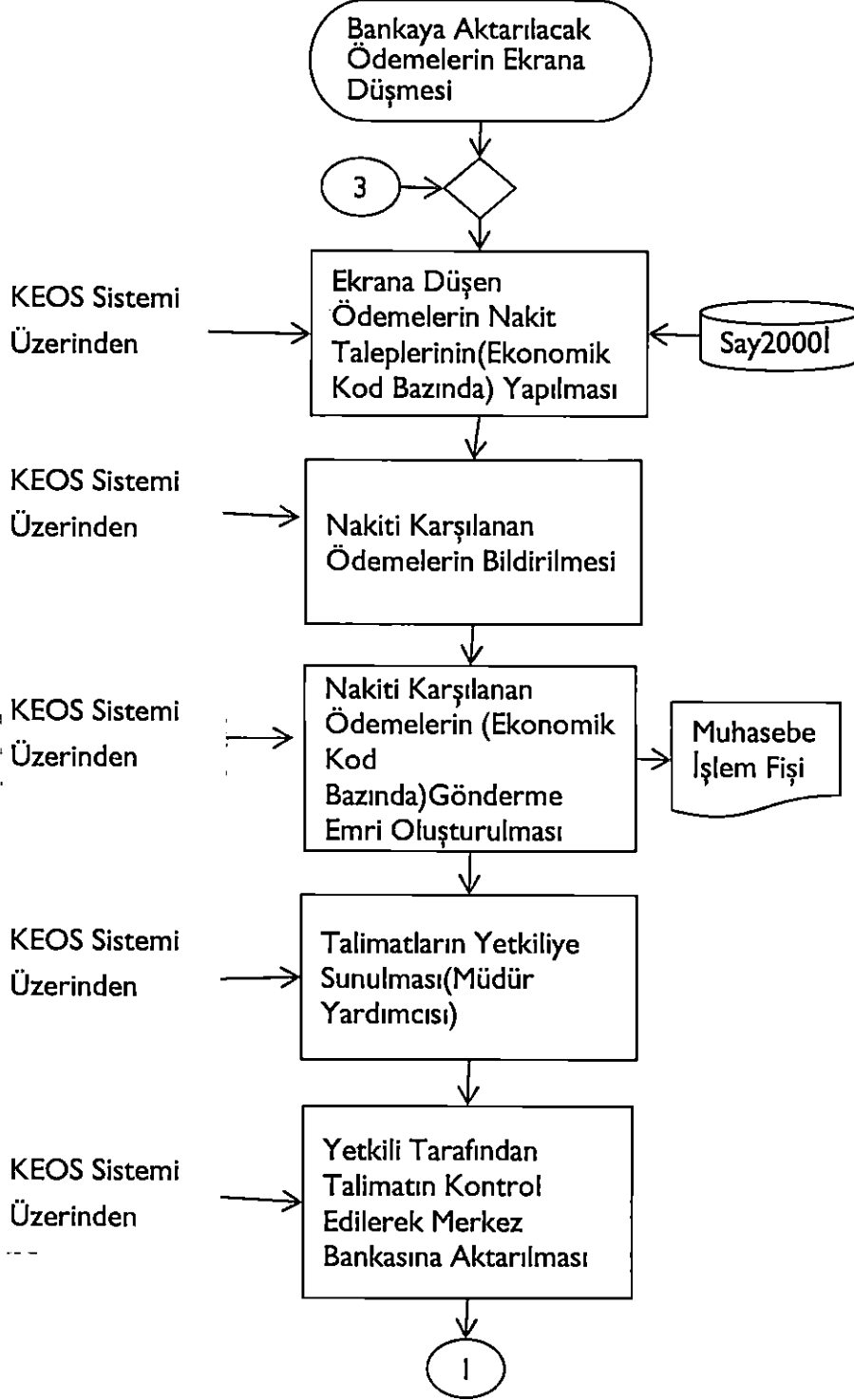

Hazırlayan:	Onaylayan:
Türkan Tarcan Muhasebe Şefi	Kadri Ay Muhasebe Müdürü

Banka Servisi Ödeme İşlem Süreci

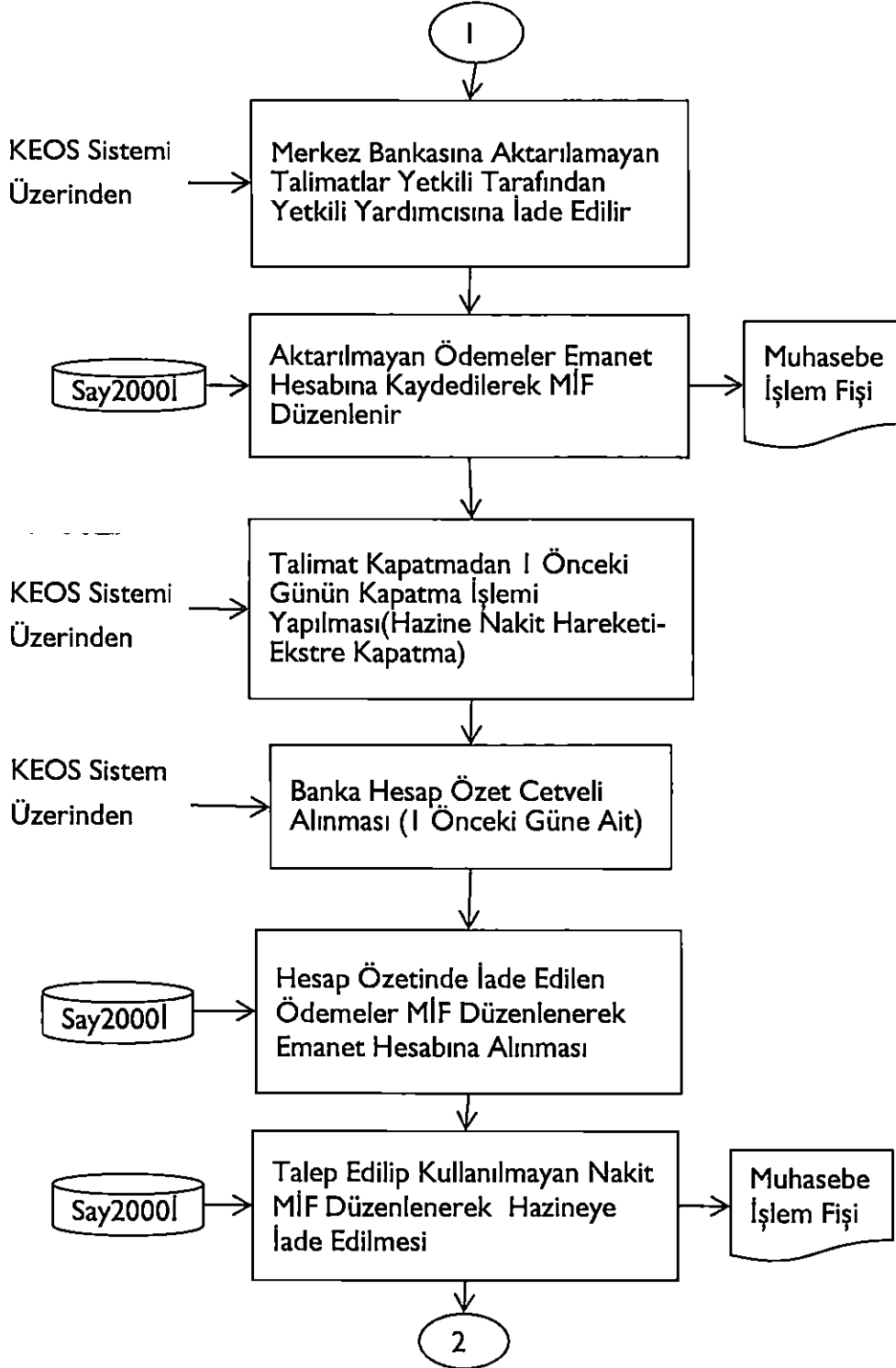

Hazırlayan:	Onaylayan:
Türkan Tarcan Muhasebe Şefi	Kadri Ay Muhasebe Müdürü

Banka Servisi Tahsilat İşlem Süreci

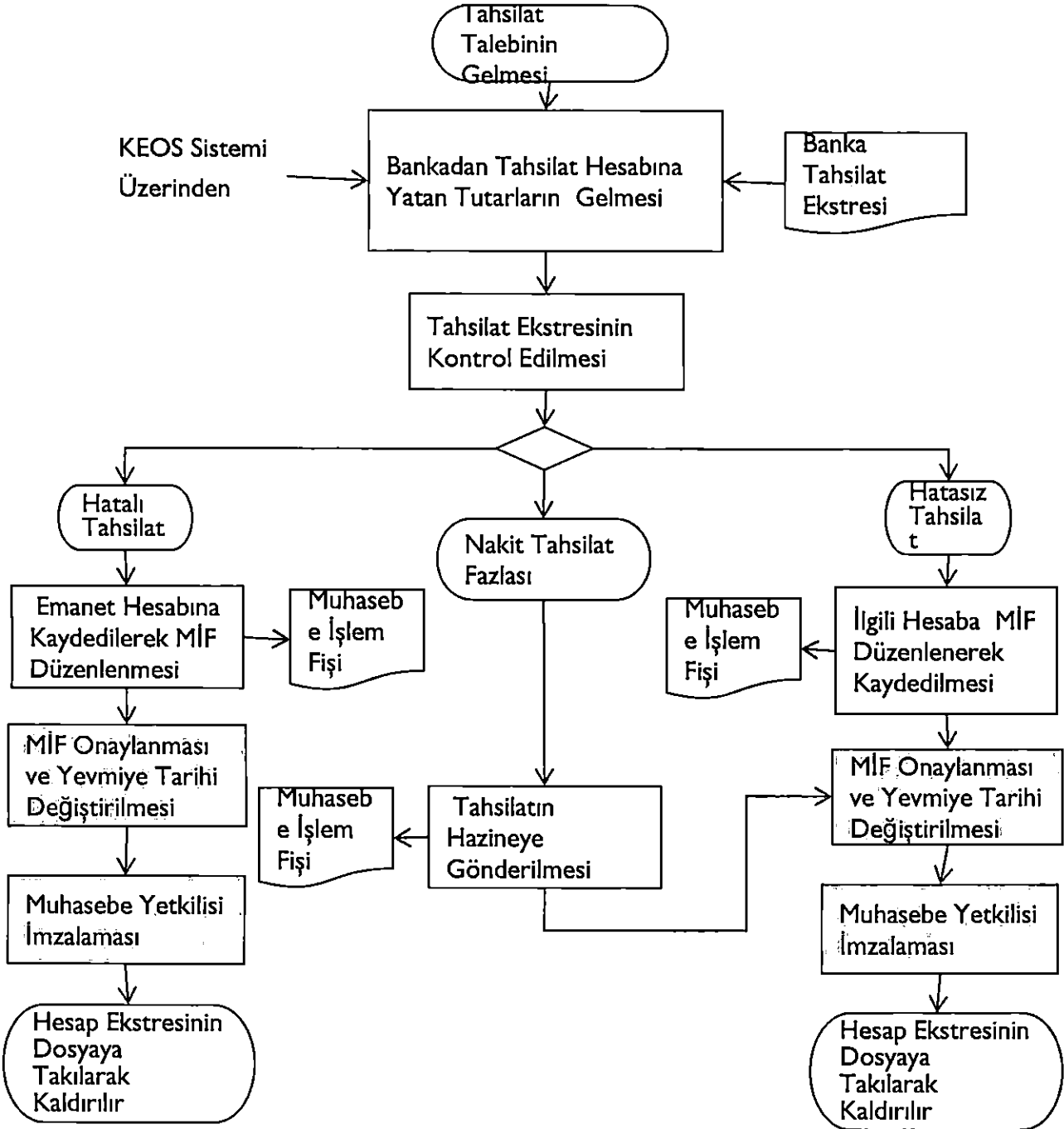

Hazırlayan:	Onaylayan:
Türkan TARCAN Muhasebe Şefi	Kadri AY Muhasebe Müdürü

Bütçe Emaneti İşlem Süreci

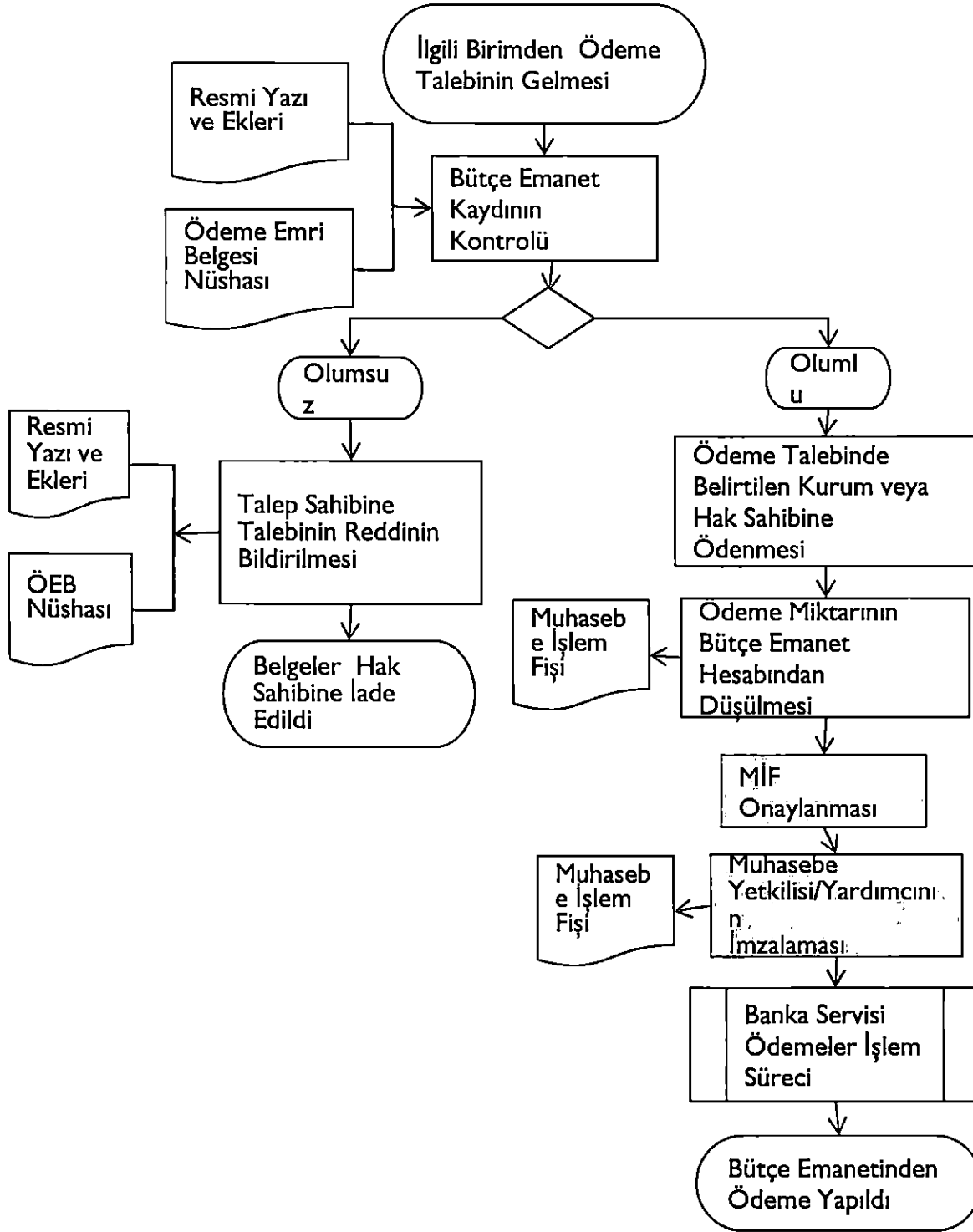

Hazırlayan:	Onaylayan:
Türkan Tarcan Muhasebe Şefi	Kadri AY Muhasebe Müdürü

Bütçeleştirilmiş Borç İşlem Süreci

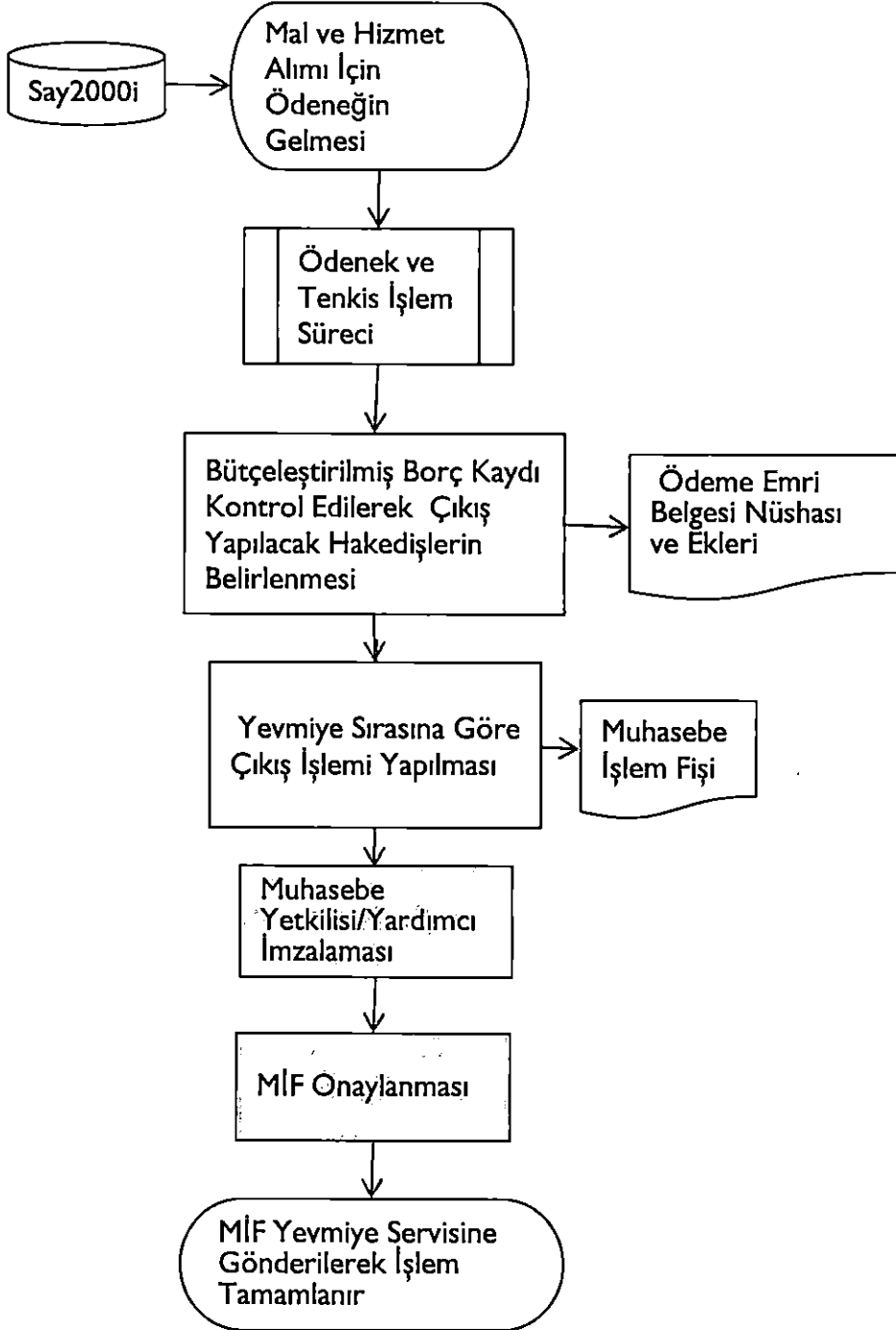

Hazırlayan:	Onaylayan:
Türkan TARCAN Muhasebe Şefi	Kadri AY Muhasebe Müdürü



Banka Servisi Ödeme İşlem Süreci

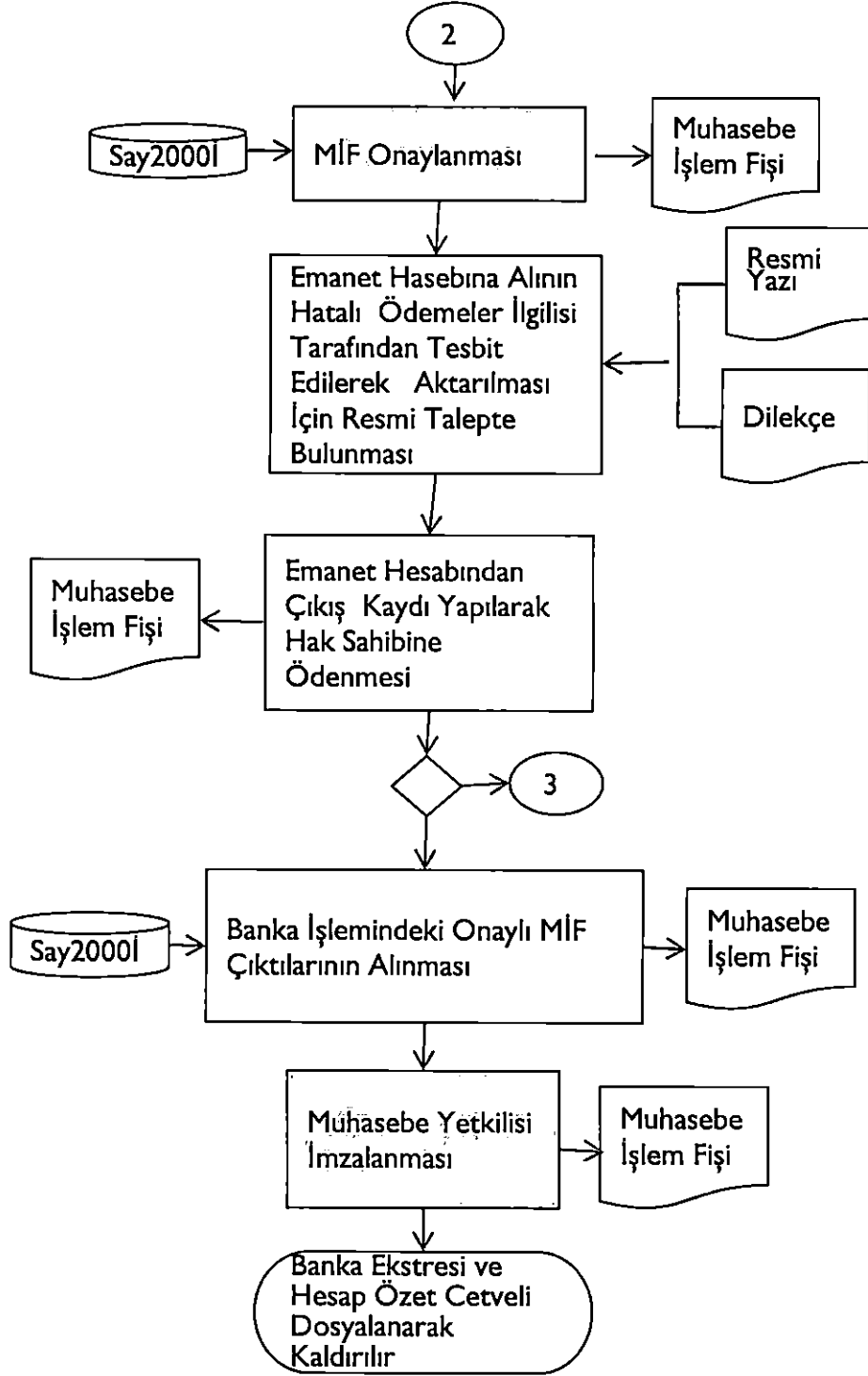

Hazırlayan:	Onaylayan:
Türkan Tarcan Muhasebe Şefi	Kadri Ay Muhasebe Müdürü

Gelir Servisi İşlem Süreci

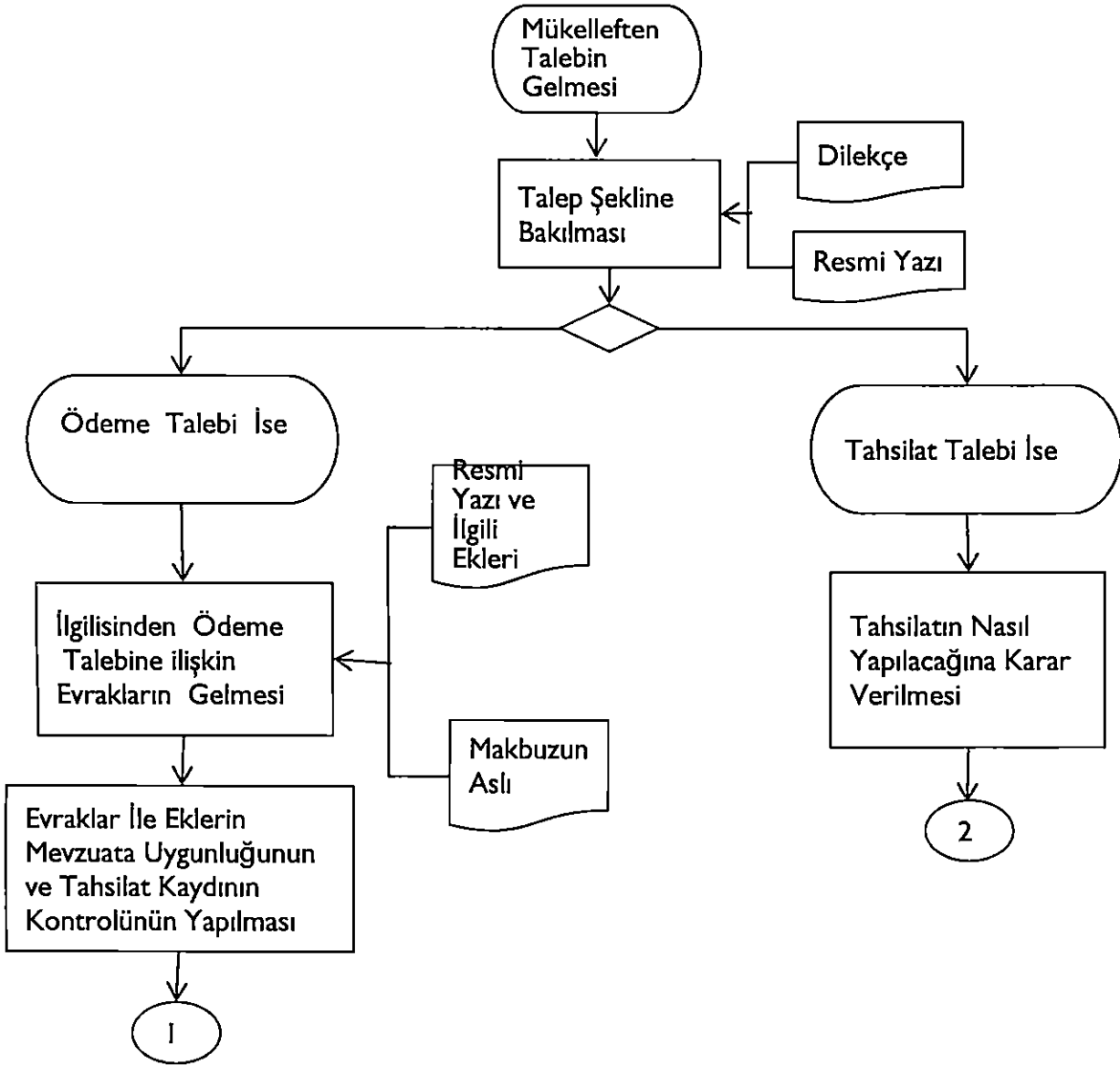

Hazırlayan:	Onaylayan:
Türkan TARCAN Muhasebe Şefi	Kadri AY Muhasebe Müdürü

Gelir Servisi İşlem Süreci

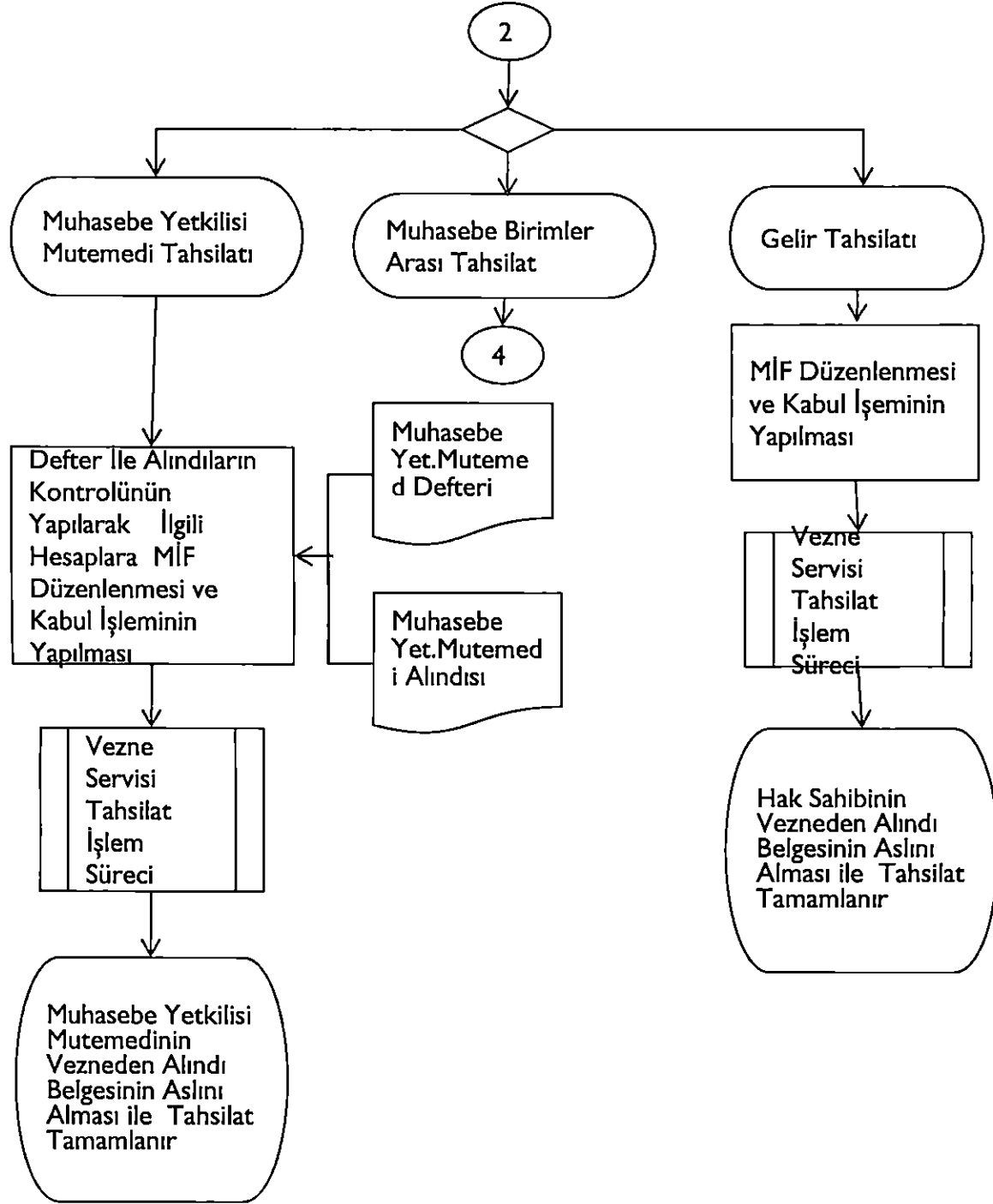

Hazırlayan:

Türkan TARCAN
Muhasebe Şefi

Onaylayan:

Kadri AY
Muhasebe Müdürü

Gelir Servisi İşlem Süreci

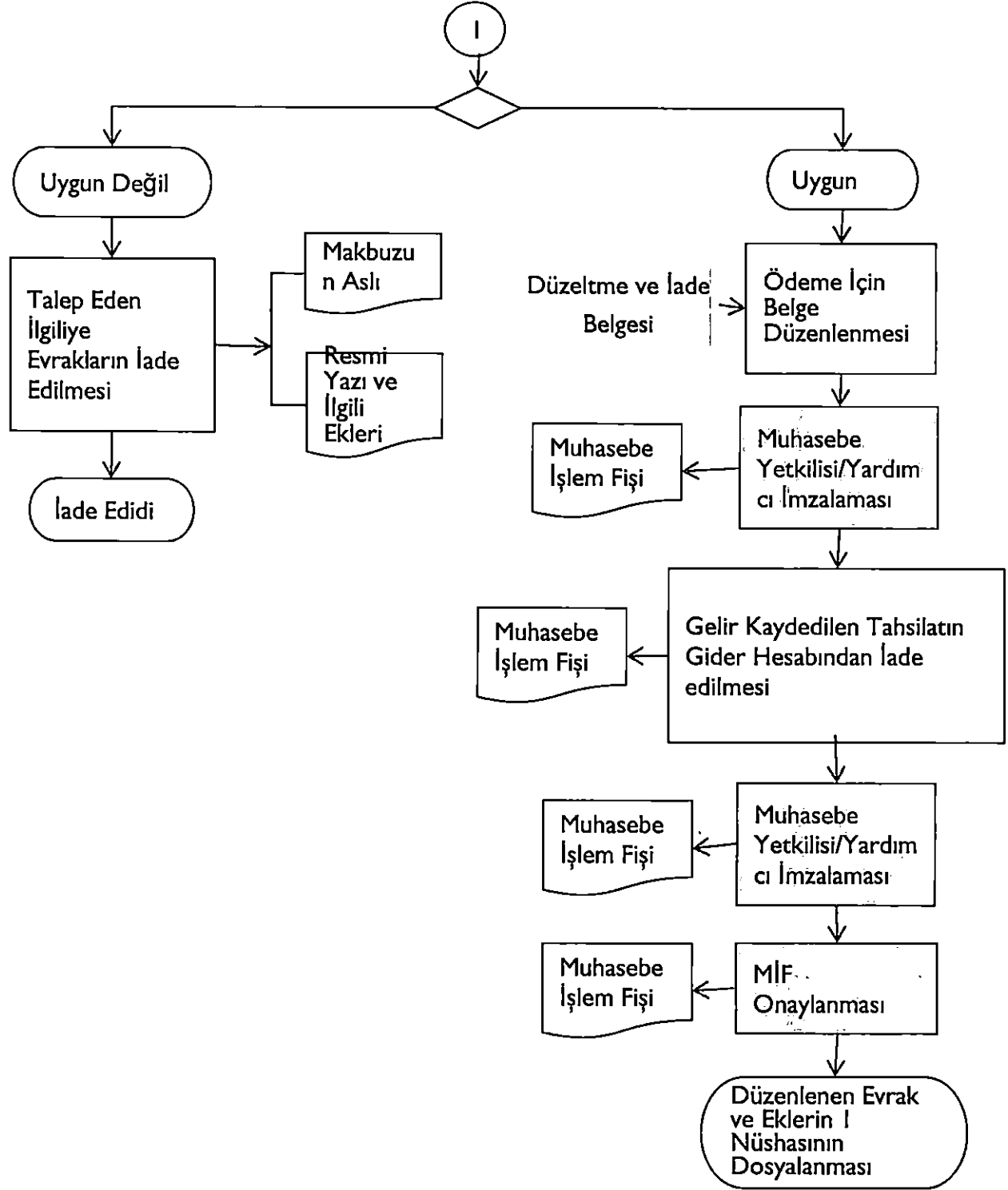

Hazırlayan:	Onaylayan:
Türkan TARCAN Muhasebe Şefi	Kadri AY Muhasebe Müdürü

Gelir Servisi İşlem Süreci

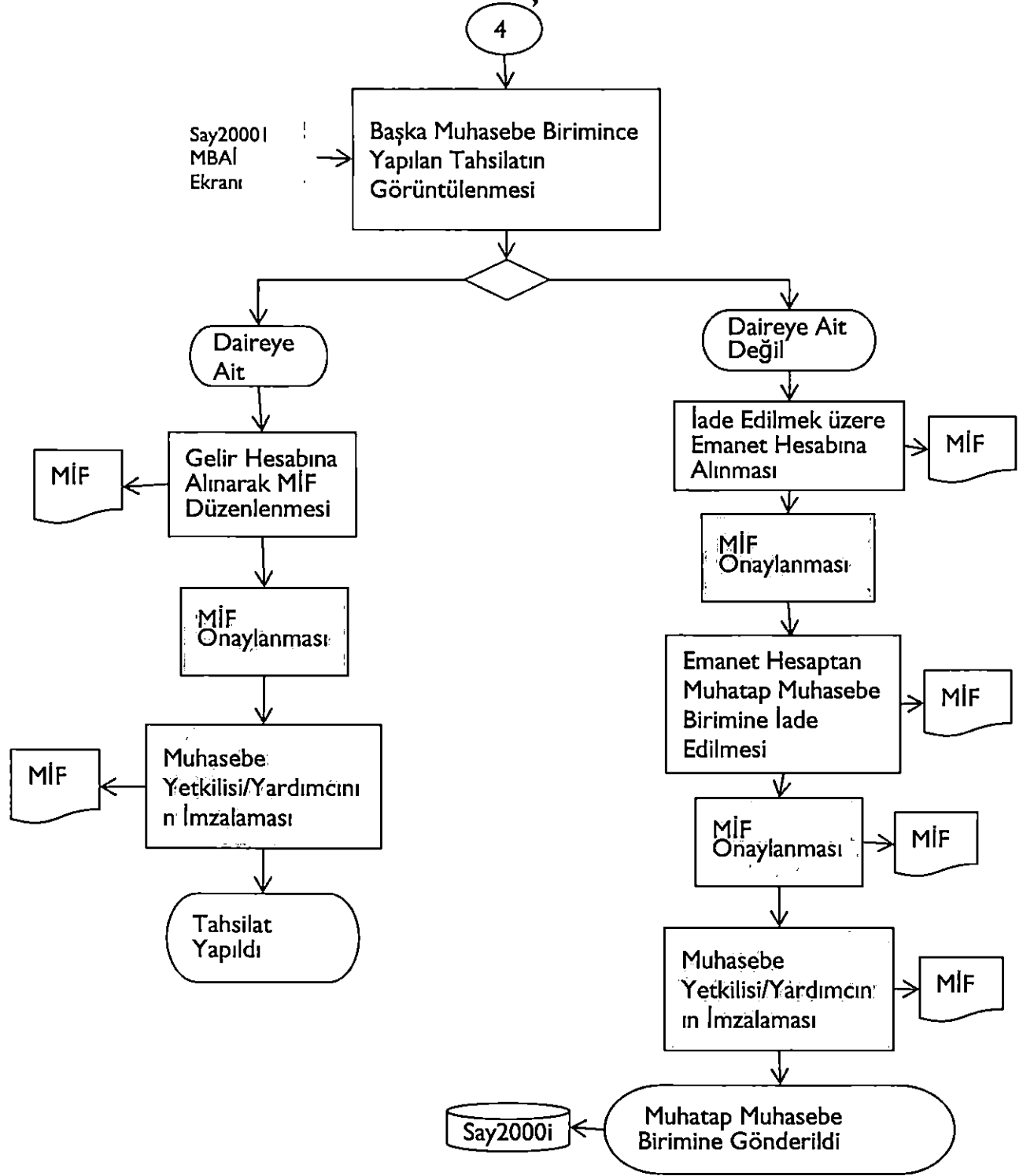

Hazırlayan:	Onaylayan:
Türkan TARCAN Muhasebe Şefi	Kadri AY Muhasebe Müdürü

KBS Şifre Verme İşlem Süreci

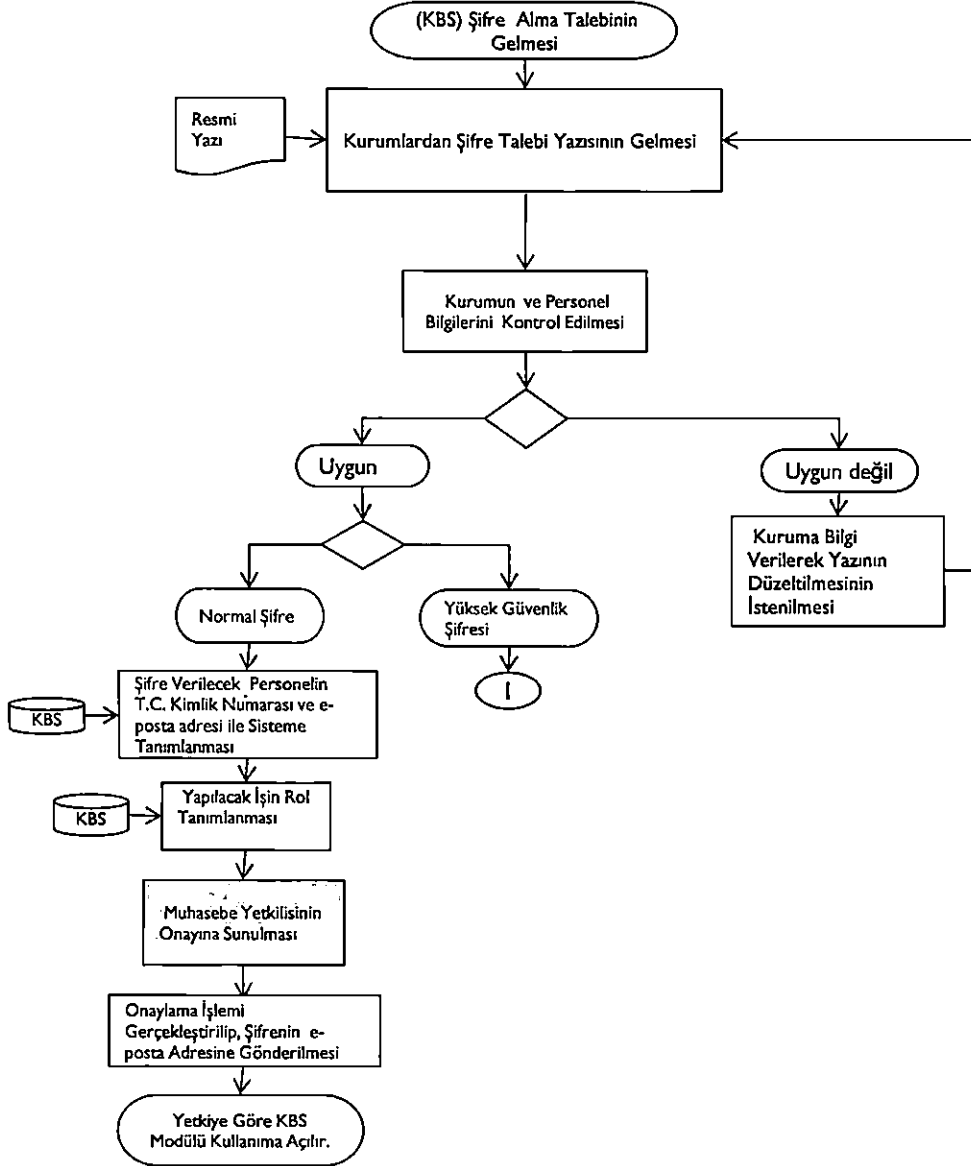

Hazırlayan:	Onaylayan:
Türkan TARCAN Muhasebe Şefi	Kadri AY Muhasebe Müdürü

KBS Şifre Verme İşlem Süreci

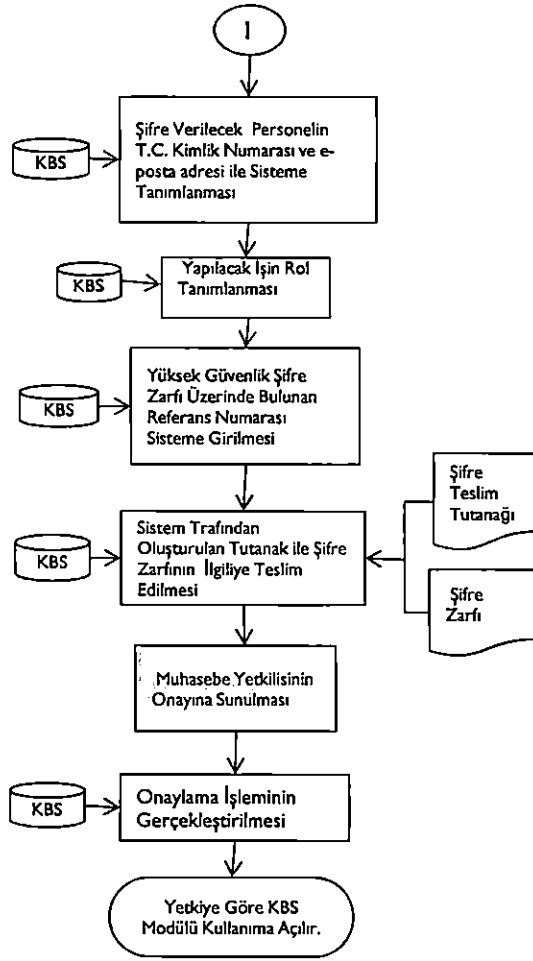

Hazırlayan:	Onaylayan:
Türkan TARCAN Muhasebe Şefi	Kadri AY Muhasebe Müdürü

Kişi Alacakları Tahsilatı İşlem Süreci

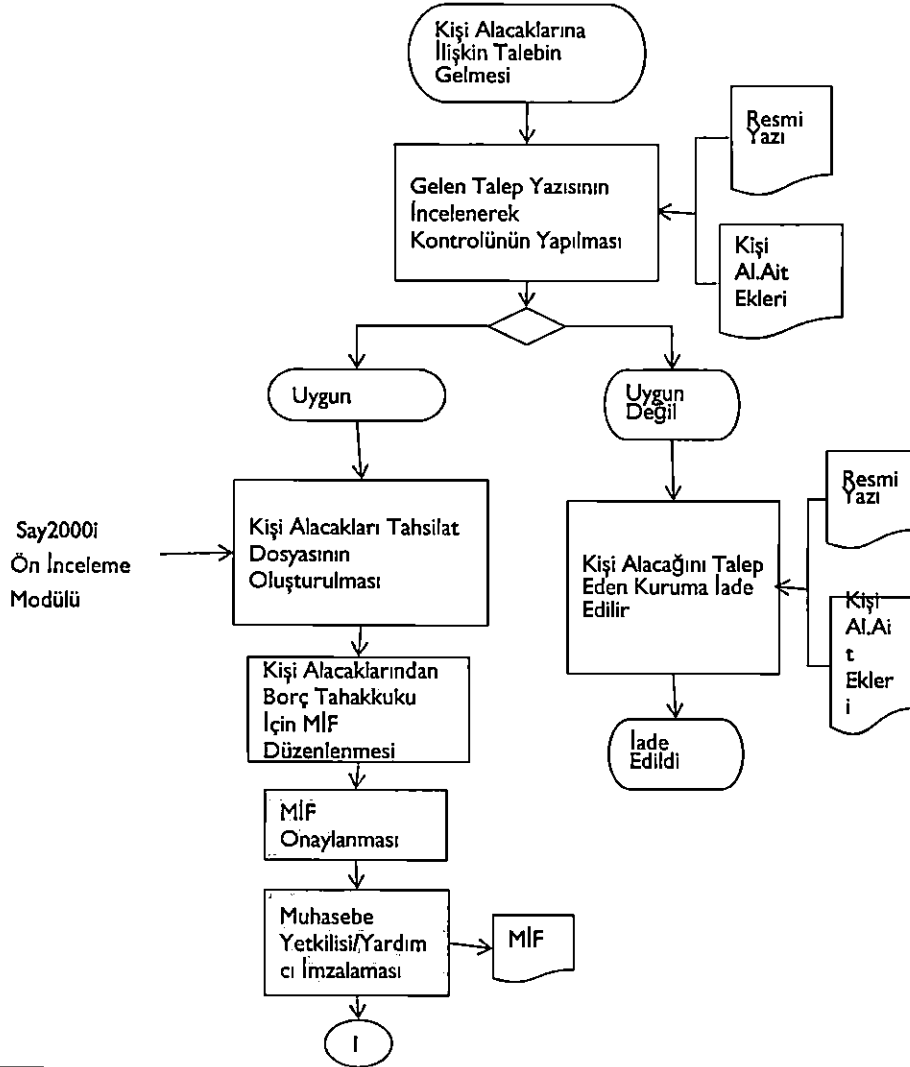

Türkan TARCAN
Muhasebe Şefi

Kadri AY
Muhasebe Yetkilisi

Kişi Alacakları Tahsilatı İşlem Süreci

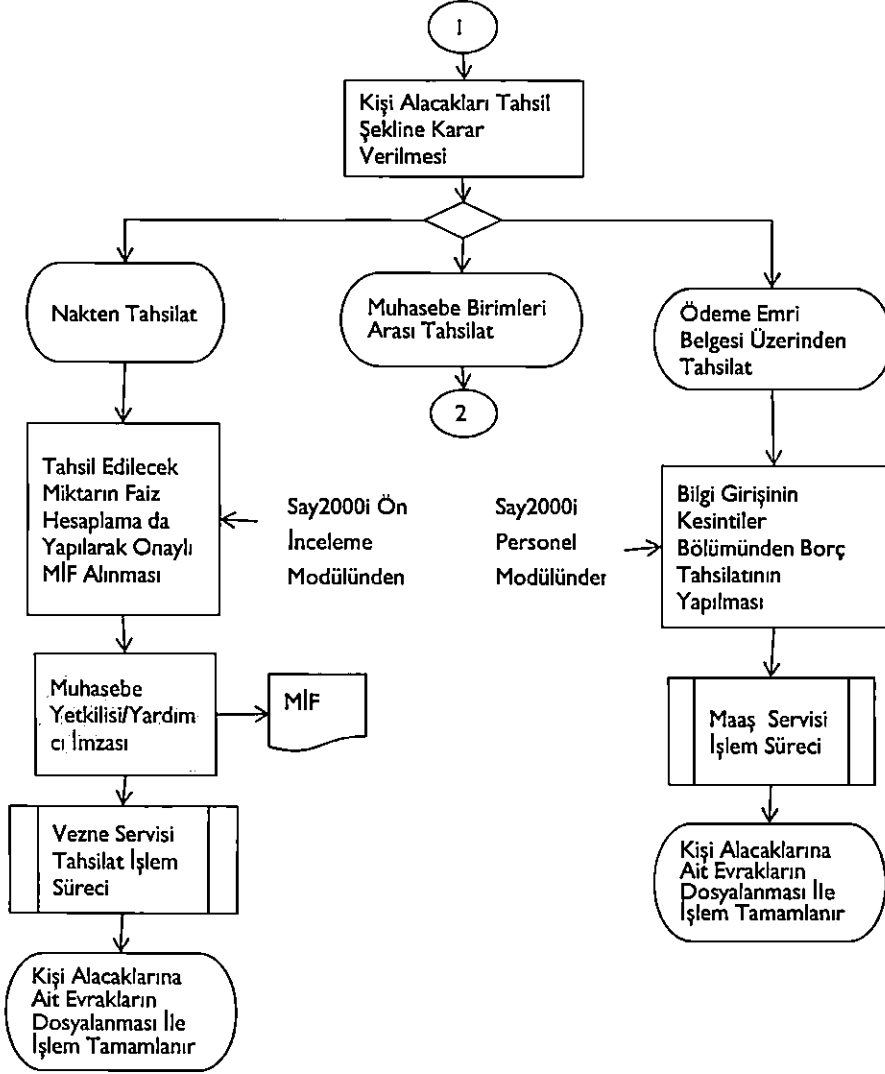

Hazırlayan:	Onaylayan:
Türkan TARCAN Muhasebe Şefi	Kadri AY Muhasebe Yetkilisi

Kişi Alacakları Tahsilatı İşlem Süreci

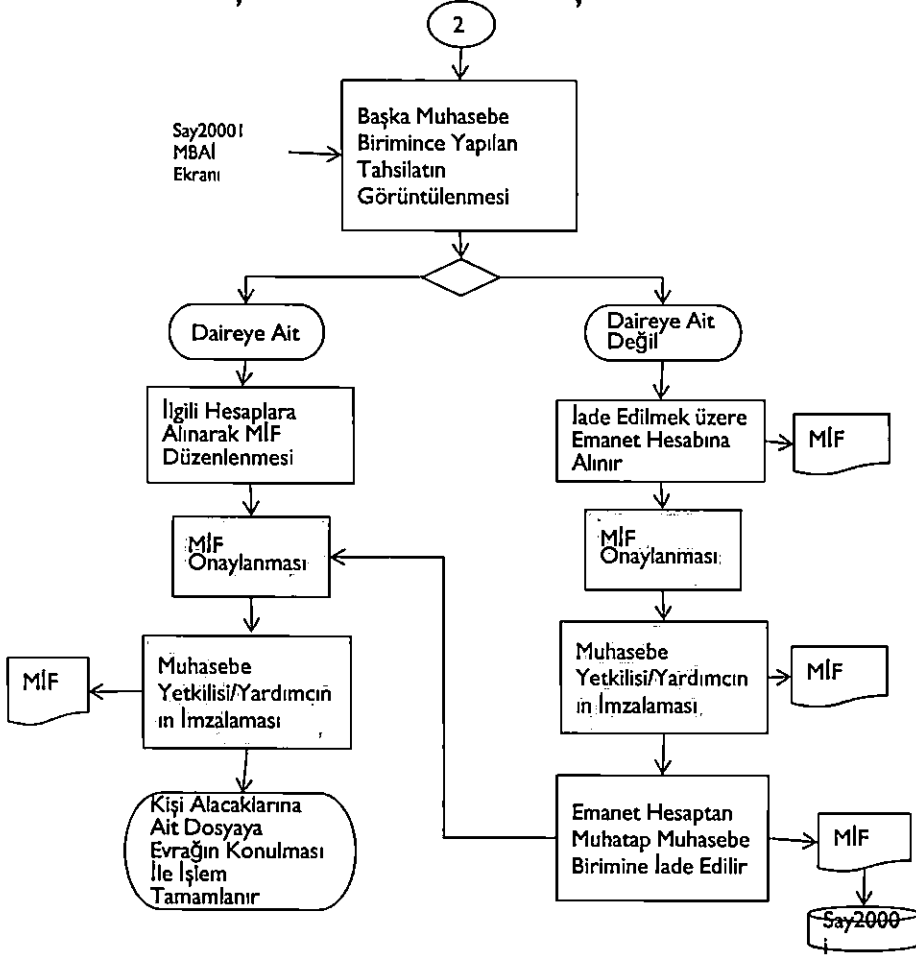

Hazırlayan:	Onaylayan:
Türkan TARCAN Muhasebe Şefi	Kadri AY Muhasebe Yetkilisi

Maaş Servisi İşlem Süreci

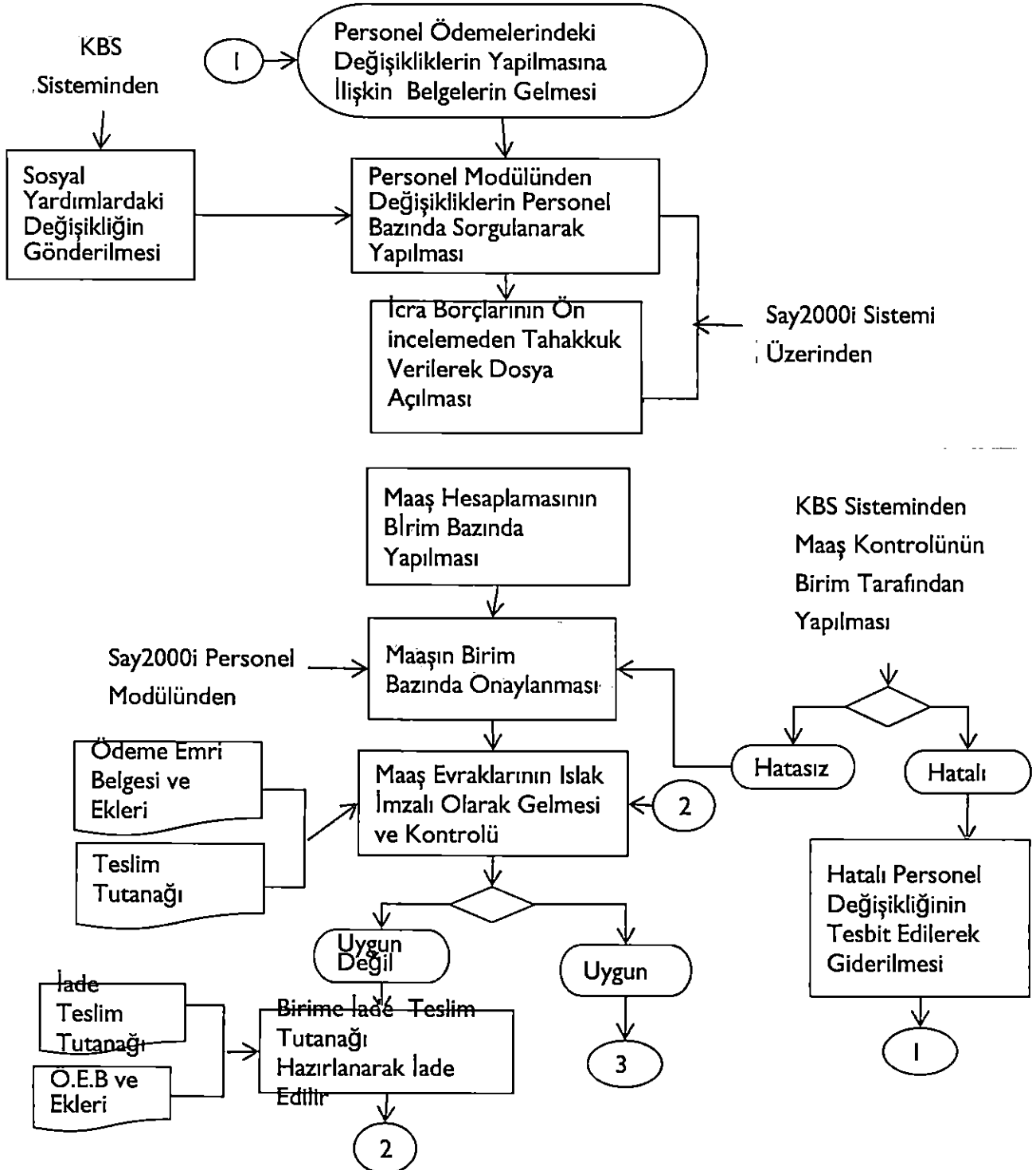

Hazırlayan:	Onaylayan:
Türkan TARCAN Muhasebe Şefi	Kadri AY Muhasebe Müdürü

Maaş Servisi İşlem Süreci

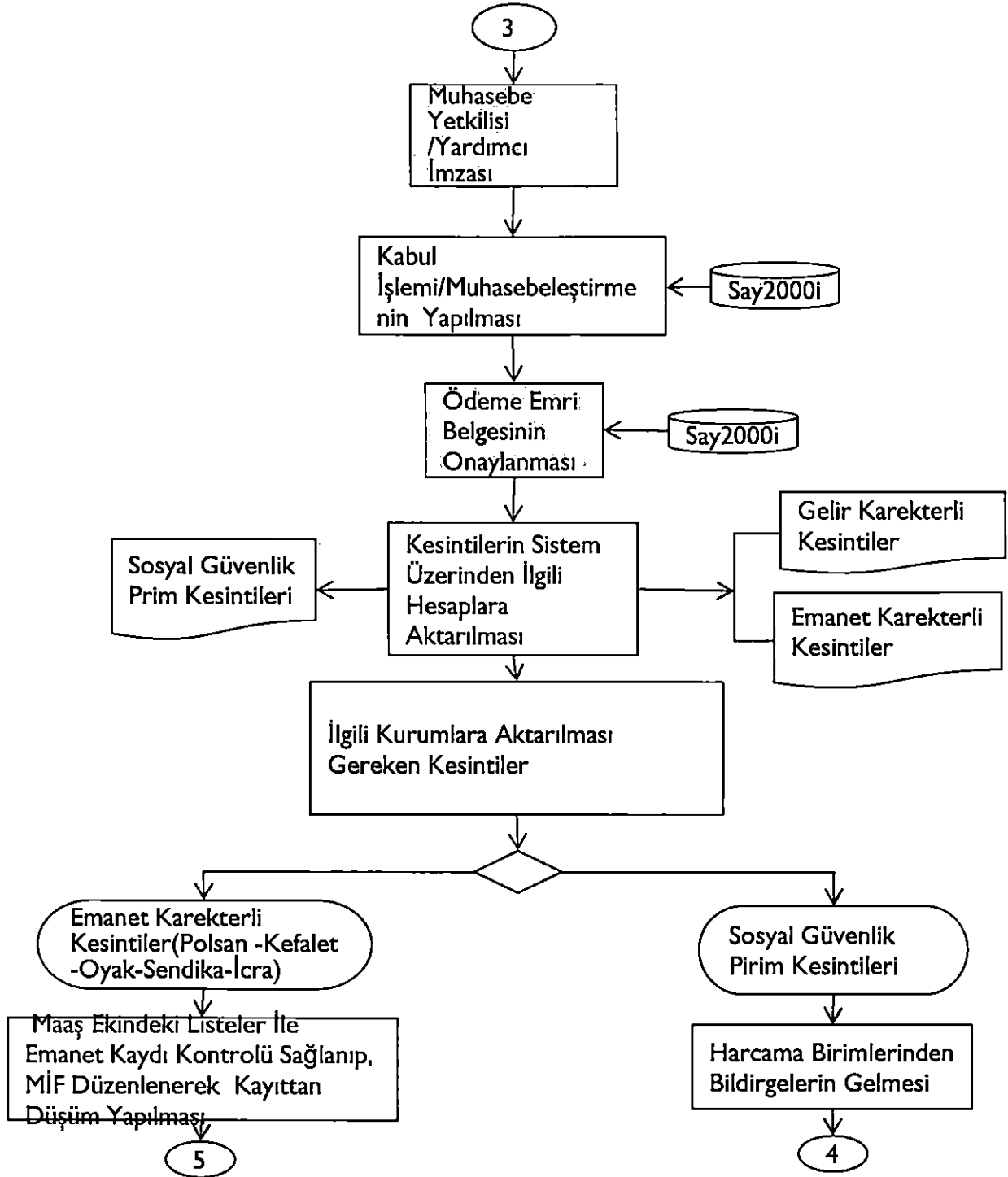

Hazırlayan:	Onaylayan:
Türkan TARCAN Muhasebe Şefi	Kadri AY Muhasebe Müdürü

Maaş Servisi İşlem Süreci

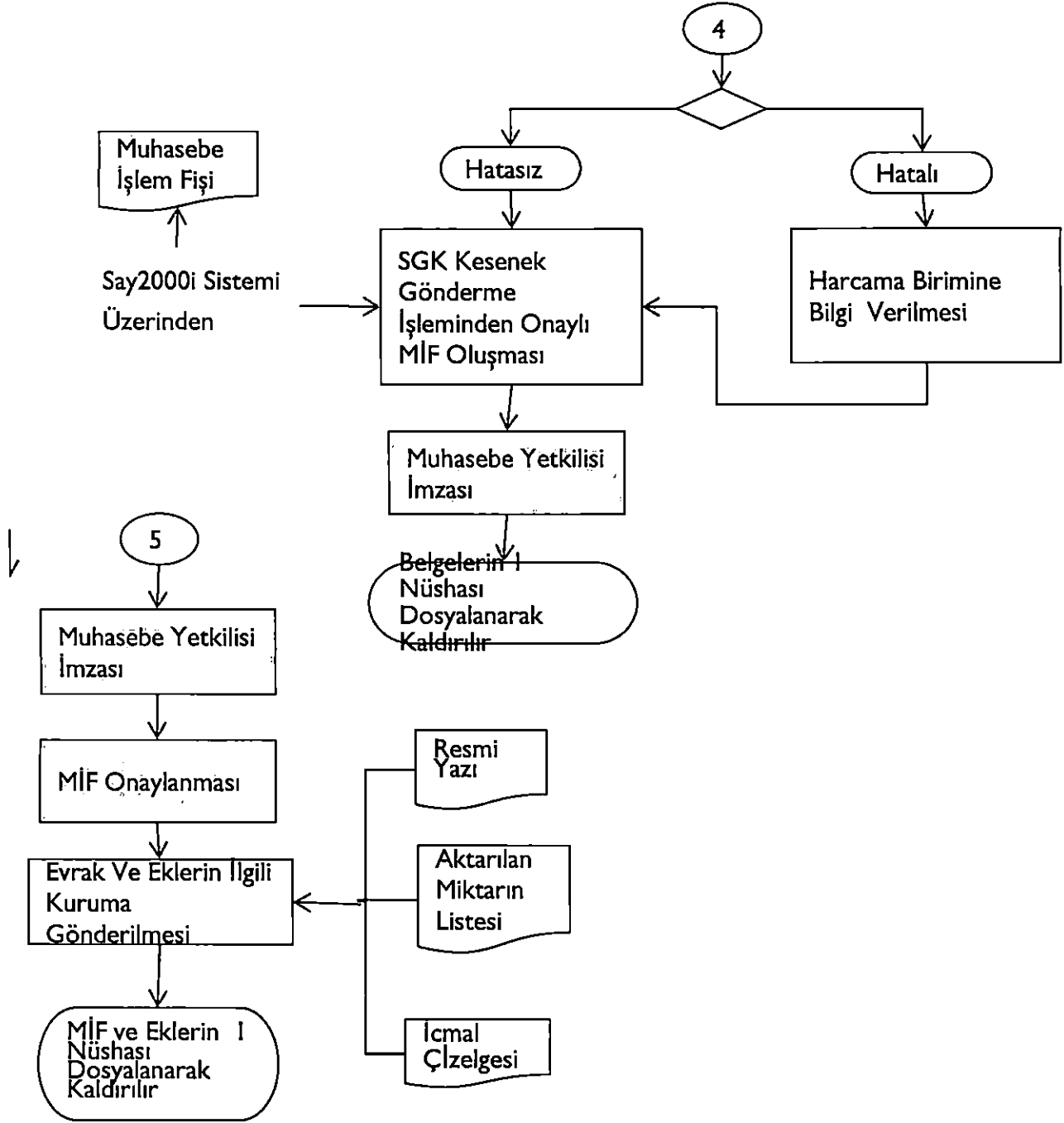

Hazırlayan:	Onaylayan:
Türkan TARCAN Muhasebe Şefi	Kadri AY Muhasebe Müdürü

Mahalli İdare Verileri İşlem Süreci

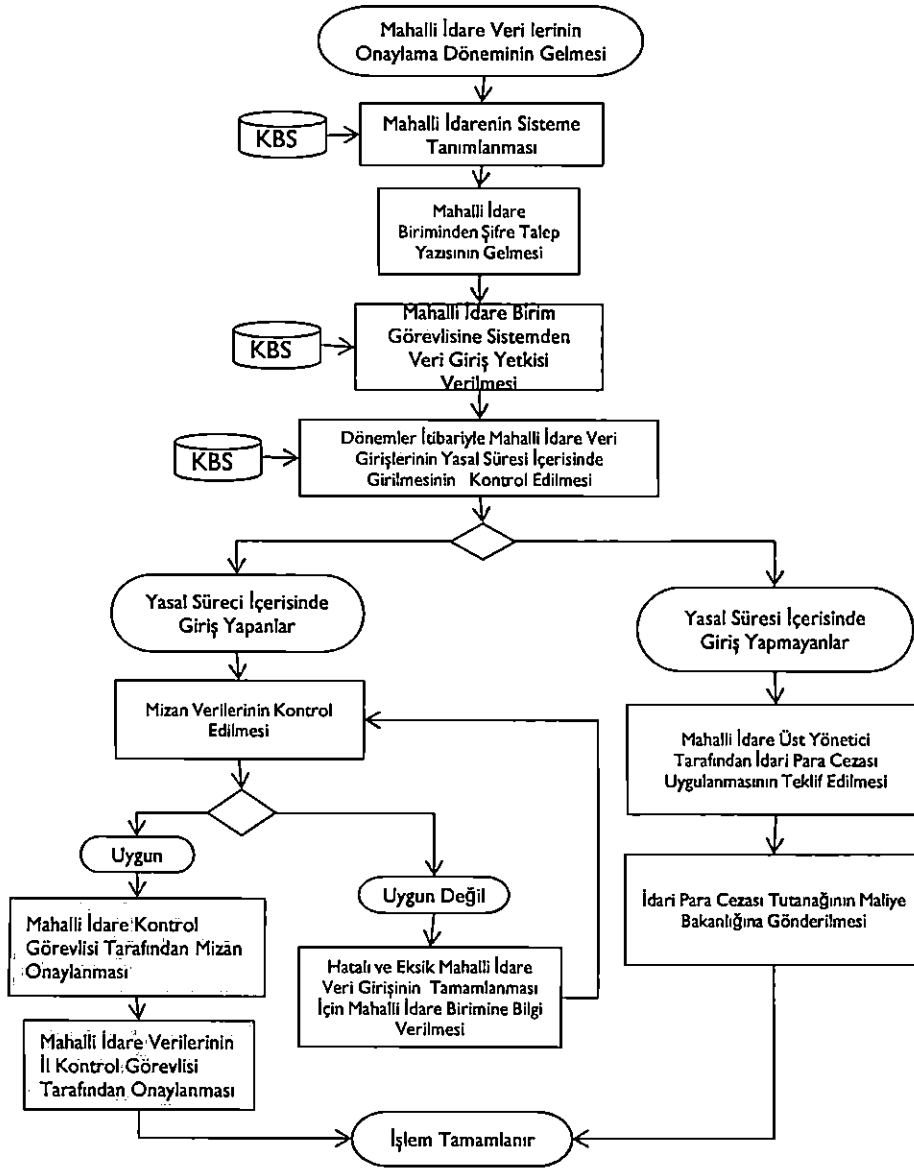

Hazırlayan:	Onaylayan:
Türkan TARCAN Muhasebe Şefi	Kadri AY Muhasebe Yetkilisi

Ödenek/Tenkis İşlem Süreci

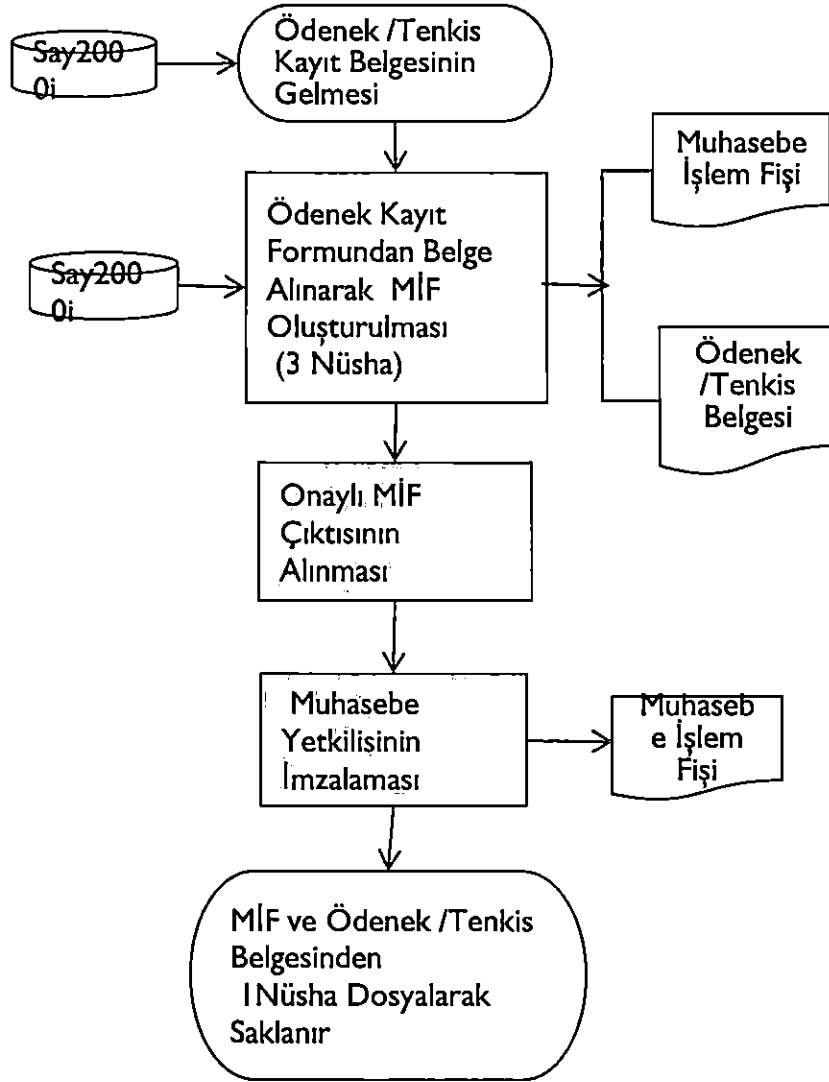

Hazırlayan:	Onaylayan:
Türkan TARCAN Muhasebe Şefi	Kadri AY Muhasebe Müdürü

Ön Ödemeye (Avans) İşlem Süreci

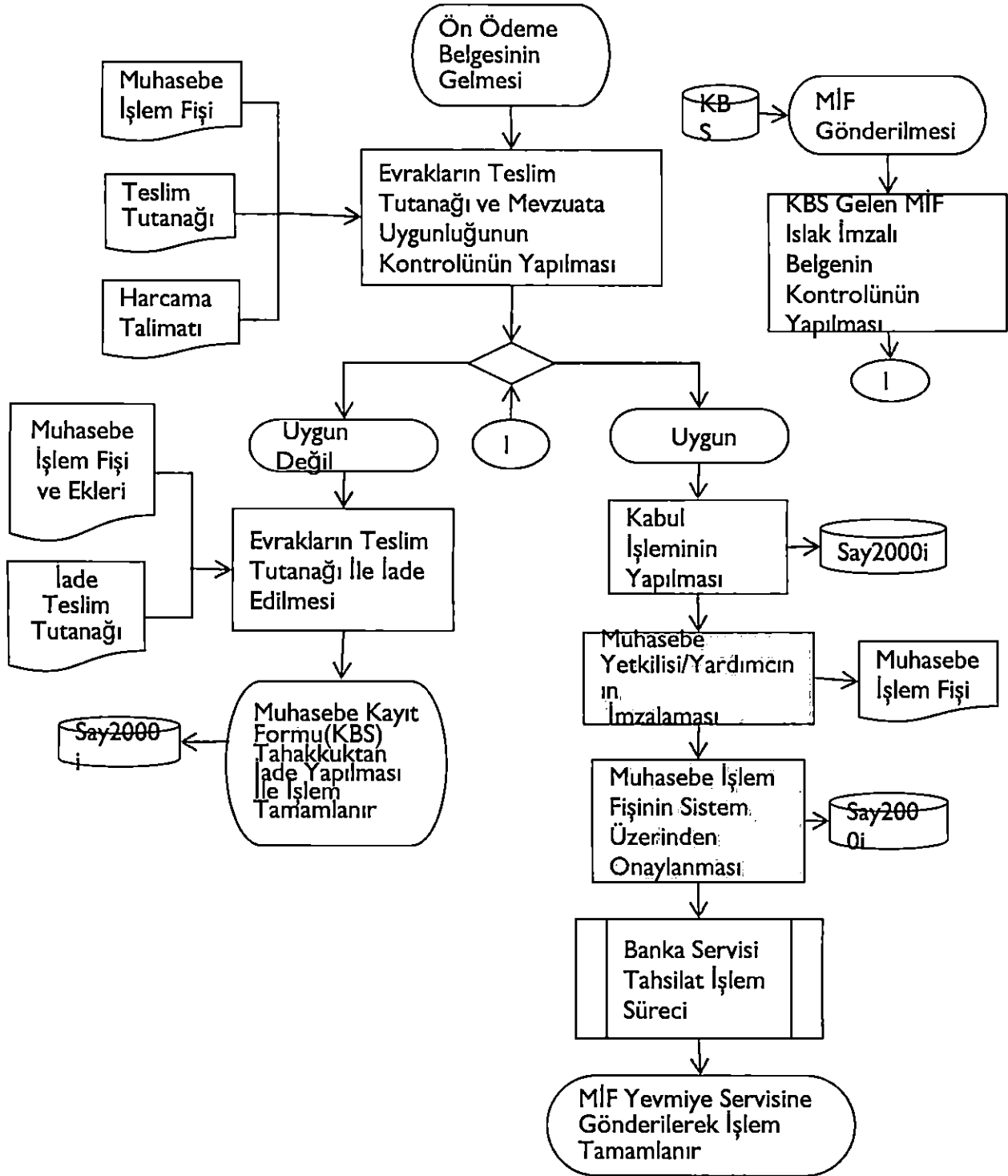

Hazırlayan:	Onaylayan:
Türkan TARCAN Muhasebe Şefi	Kadri AY Muhasebe Müdürü

Özlük Servisi Personel Yazışma İşlem Süreci

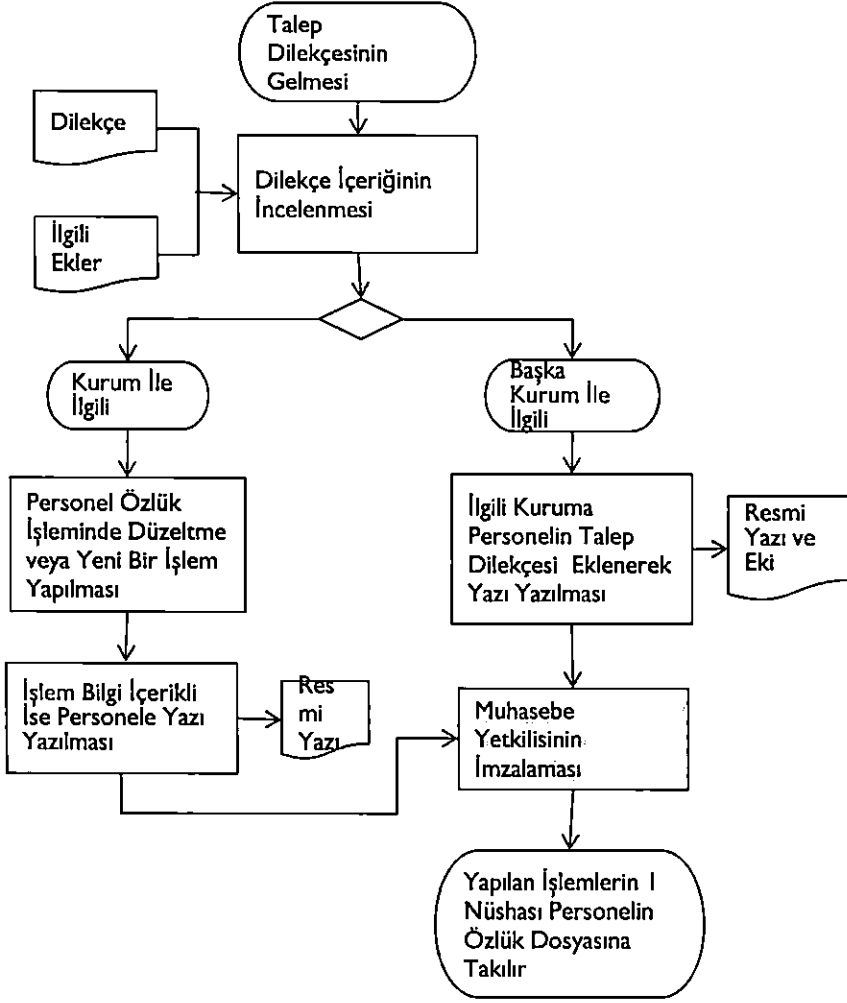

Hazırlayan:	Onaylayan:
Türkan TARCAN Muhasebe Şefi	Kadri AY Muhasebe Müdürü

Özlük Servisi İzin İşlem Süreci

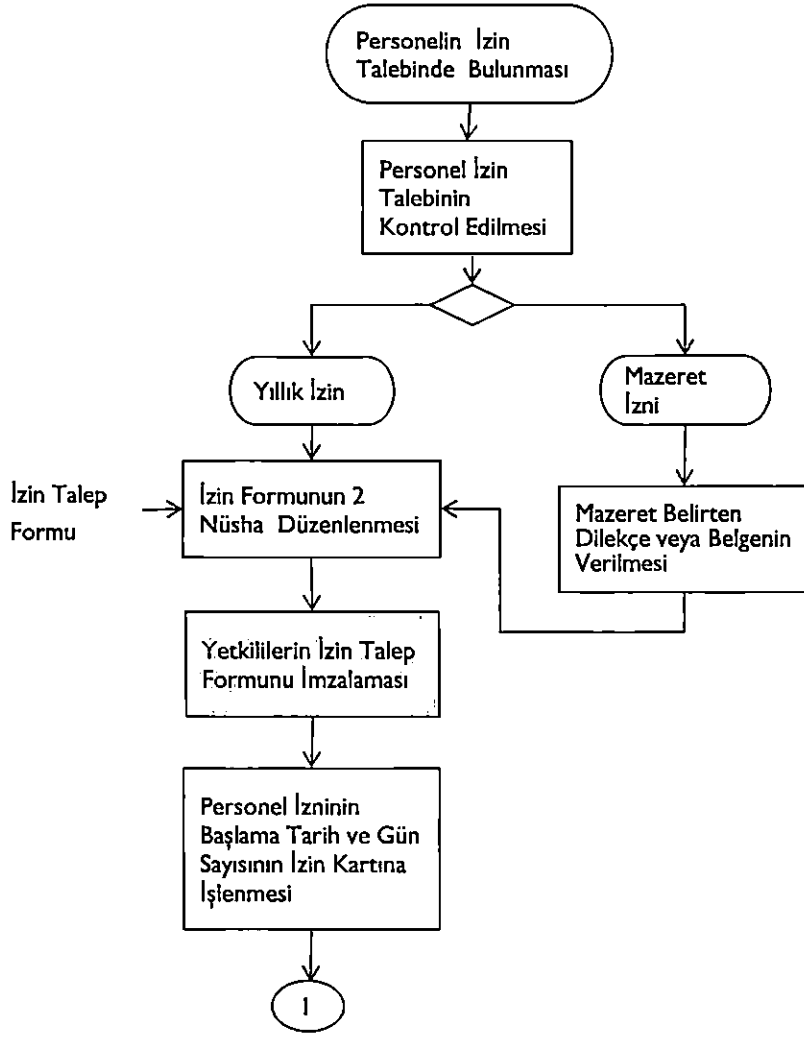

Hazırlayan:	Onaylayan:
Türkan TARCAN Muhasebe Şefi	Kadri AY Muhasebe Müdürü



Özlük Servisi İzin İşlem Süreci

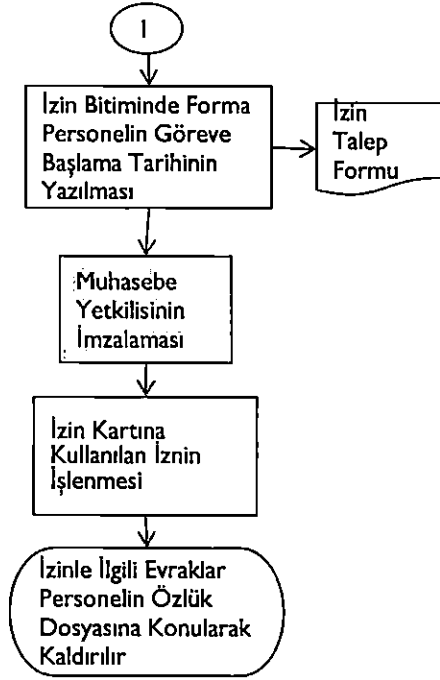

Hazırlayan:	Onaylayan:
Türkan TARCAN Muhasebe Şefi	Kadri AY Muhasebe Müdürü